

# Door Catalog <sup>2012</sup>



Entry Doors  
Patio Doors  
Storm Doors



 **ProVia**<sup>®</sup>  
THE PROFESSIONAL WAY



What  
Makes *ProVia*

# Professional-Class?

## Highest Standards

ProVia is committed to making doors the professional way; doors individually customized for homeowners to **the highest standards of durability, security and energy efficiency** in the residential market. A clear difference so defining that it has established a new category of professional-class doors, a better alternative to consumer-grade doors.



### Beauty

A beautiful ProVia entry system will always greet your guests with classic elegance and style.



### Durability

Made with the finest materials and backed by our Lifetime Limited Transferable Warranty, our durability can't be beat.



### Security

We focus on the strength and security of every door so you can focus on what's really important-your life.



### Energy Efficiency

Engineered to keep the elements at bay and your home comfortable all year long.



### Our Culture

We've been building a reputation for quality since our company was founded over 30 years ago near Sugarcreek, Ohio, in the heart of Amish country, an area well known for quality and craftsmanship.

While old-world craftsmanship is very much a part of our culture, it's supported by modern design techniques and state-of-the-art manufacturing processes. We've created the perfect balance between traditional quality and modern technology.

# Customized for You

An entry system is a reflection of you and your style. What ProVia offers is the freedom to have a door just the way you want, perfectly complementing your personality. Each made-to-measure door is a creation of it's own—**uniquely customized in 3 easy steps:**

- 1** Choose your door's **construction** from beautiful **Signet®** or **Heritage™** Fiberglass or **Legacy™** Woodgrain Textured or Smooth Steel.
- 2** Create the perfect entry from a wide range of **glass options** and door styles.
- 3** Add the **finishing touches** of hardware & accessories.

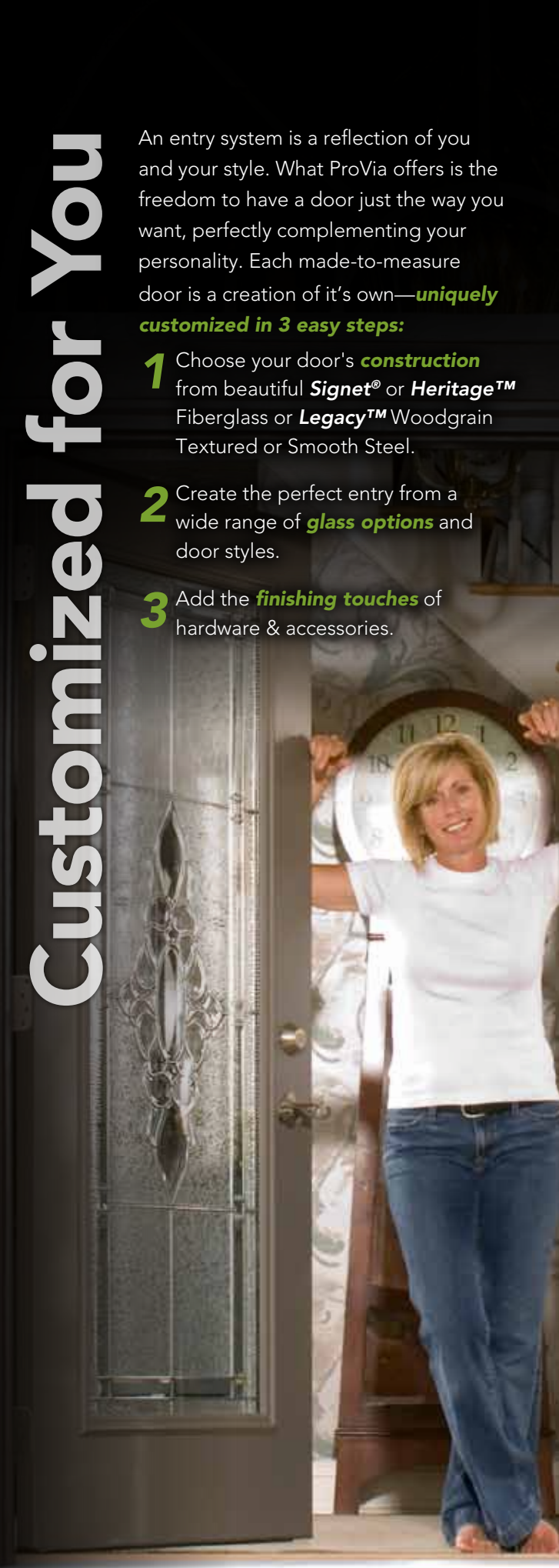

## ENTRY DOORS

### DOOR CONSTRUCTION

Features & Benefits .....	4
Signet® Fiberglass Features .....	6
Heritage™ Fiberglass Features .....	8
Legacy™ Steel Door Features .....	10

### GLASS

#### ComforTech™ Glazing Systems

ComforTech Benefits .....	12
---------------------------	----

#### Decorative Glass

Cheyenne.....	14
Brilliance .....	16
Glenmore.....	18
St. Jane .....	20
Crystal .....	22
Santa Fe.....	24
Solitaire .....	26
Barcelona .....	28
Radiant Hues .....	30
Tranquility .....	32
Classic .....	34
Lehigh .....	36
Emerald.....	38
Beveled.....	40
Diamond .....	42
Tuscany.....	44
Twilight.....	46

#### Inspirations™ Art Glass .....

#### Privacy Glass

Taffeta.....	50
Chinchilla .....	50
Waterfall.....	50
Gluechip .....	50
Obscure Pebble .....	50

#### Clear Glass

Internal Blinds .....	52
Internal Grids .....	54
External Grids .....	56
Clear Glass.....	58

#### Doors Without Glass.....

	60
--	----

### FINISHING TOUCHES

Finishes .....	62
Hardware.....	66
Cladding & Casing.....	76
InVent™ Retractable Screens .....	76
Freedom Pet Doors .....	76

#### 8' Doors.....

	78
--	----

#### French Doors.....

	80
--	----

## PATIO DOORS

Hinged Patio Doors .....	82
Prestige™ Vinyl Patio Doors .....	84

## STORM DOORS

Features and Benefits .....	88
Spectrum™ Storm Doors .....	92
Decorator Storm Doors .....	94
Deluxe Storm Doors .....	96
DuraGuard Storm Doors .....	98
Superview Storm Doors.....	100
Hardware.....	102
Accessories .....	106

Door Construction

Glass

Finishing Touches

Patio Doors

Storm Doors

# Environmental Stewardship



ENERGY STAR® qualified doors and windows are independently tested and certified to meet strict energy efficiency standards. The annual Sustained Excellence Awards are given to a select group of organizations that have exhibited outstanding leadership. ProVia has won this prestigious award 2 times and Partner of the Year 3 times. ENERGY STAR is a government backed program to help consumers identify energy efficient products.



Most of our Entry Systems are ENERGY STAR qualified.

At ProVia, not only do we manufacture energy efficient products, but we also exercise corporate environmental stewardship. Here are a few examples:

We recycle paper, metals and glass



Our Pollution Prevention Program dramatically reduced solvent usage by over 33% since 2002.



To save fuel, our trucks use the TriPac Idle Reduction and Temperature Management System.



Paperless online ordering and internal paperless fax system reduces paper use.



For more information, visit the Environmental Stewardship section of our website at [www.proviaproducts.com](http://www.proviaproducts.com)

# Tailored Just for Your Home



Nothing feels quite as good as well-tailored clothing, created specifically to your size, shape, and style preference. Off-the-rack clothing just doesn't fit everyone's measurements. Similarly, off-the-rack doors fall short of expectations in the same way.

The materials as well as the workmanship that go into custom made doors is of exceptional quality and durability, and far exceeds what is available as ready-made. Unlike consumer-grade doors, professional-class doors are customized to your exact measurements for a better fit and a more secure and energy efficient door.

*Entry systems tailored for you - that's the professional way.*



# The Components

What makes a Professional-Class door?



460LEH, 160LEH, 612/613LEH

Our **stains are hand-applied by professionals** then oven-cured for maximum beauty and durability. **State-of-the-art electrostatic paint application** ensures a beautiful even coat.



**High-performance, heat resistant window trim** is warranted not to warp, crack or pull away from the door, even in sunny or higher temperature applications.

Our **polyurethane core** reduces energy loss.

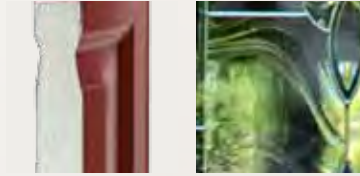

Highly skilled craftsmen assemble our Decorative Glass by precisely cutting, mitering and soldering each component into artistically designed patterns. Art glass seeks visual character through aesthetic imperfections. It achieves this through textural waves and striations, random seeds (air bubbles) and a variety of other effects. Each sheet is unique and adds beauty to any home.

**Heavy-duty ball bearing hinges** come standard with every entry system.

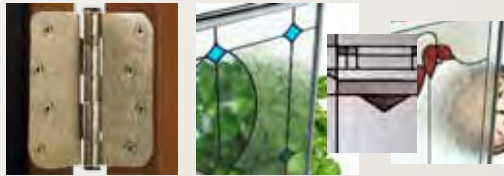

Our **INSPIRATIONS™ Art Glass** offers color accents in a wide range of designs that will make a unique statement your neighbors will be sure to notice.

We include our **20-gauge security plate** for extra strength and to help prevent kick-ins.

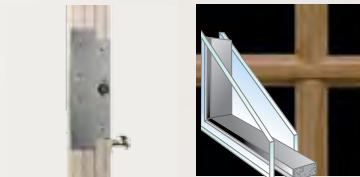

Your home is unique and deserves to have **custom glass options** like our ComforTech Warm Edge Glazing Systems, internal blinds, and many grid patterns and colors.

We include a **solid brass fully adjustable strike plate** of our own exclusive design. This unique 2-piece construction makes our doors easier to custom fit.



We offer **hardware from Emtek® and Schlage®** that provides some of the most stylish, durable hardware available today.

The **dust box** in the deadbolt strike provides a barrier to air infiltration while providing a neat appearance that most other door manufacturers don't provide.



Rot-resistant wood frame and brickmold is treated with **PineGuard™** and carries a Lifetime Limited Warranty when used with **PVC vinyl coated aluminum frame cladding** outside.

The energy efficient **Q-Lon weatherstripping** runs along the top and sides of the door and interlocks with the **NEW CornerShield™** for the most efficient seal you'll find for keeping moisture, air and dirt out of your home.

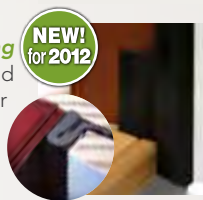

Our **2 1/2" casing** conveniently covers paint lines providing a professional installation. **Also available in 3 1/2"**. Choose from Cherry, Mahogany, Oak and Poplar.

Our exclusive **Sahara™ heavy-duty extruded threshold** has a 1 1/2" wide thermal barrier oak-like riser that will not warp or rot while providing excellent energy efficiency. Also available with an anodized brass or bronze finish. Bronze threshold comes with a color coordinated riser.



**Steel L-Frame**

Our Steel L-Frame is a great solution when you do not wish to remove your existing wood frame, however, not all Steel L-Frames are ENERGY STAR qualified. Visit ProVia's website for manufacturer's certification statement.



- Available on select Signet and Legacy door styles.
- Aluminum door stop provides greater security and is more durable than wood.
- Q-Lon Seal for superior energy efficiency.
- 18-gauge steel L-frame with a 12-gauge hinge plate welded on for extra strength and security

**Bulb and blade sweep** virtually eliminates drafts keeping your home comfortable.



...now that's a better alternative to consumer-grade.

# Signet® Fiberglass

Signet Fiberglass doors are available in Cherry, Mahogany, Oak and Fir Series. Structurally, the Signet door is far superior to traditional fiberglass doors with robust hardwood stiles and rails dovetailed at each corner. All Signet fiberglass doors exhibit our exclusive DuraFuse™ finishing system featuring P<sup>3</sup> Fusion, allowing us to offer an industry-best 10-year\* finish warranty.

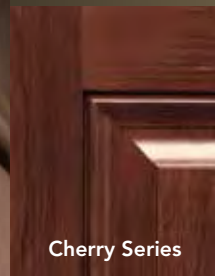

Cherry Series



Mahogany Series



Oak Series

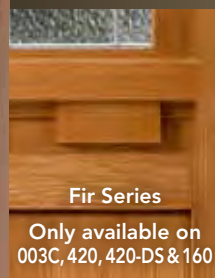

Fir Series

Only available on 003C, 420, 420-DS & 160

Patent Pending



You can customize your entry by ordering a different series, style and finish on each side of your door.

**Custom Widths & Increased Height up to 8 FEET.**

Need a little more height or a little less width? We are pleased to offer customized door & sidelite widths and heights in 1/8" increments.



**10-Year\* Finish Warranty**

for Signet Fiberglass Entry Systems

See page 64 for Signet Fiberglass paint and stain finishes

\* Warranty time period may be limited in extreme exposure applications. See warranty for details.



Most Signet Fiberglass Entry Systems are ENERGY STAR Qualified.

## Signet Fiberglass Door Styles See pages 14-59 for glass availability.

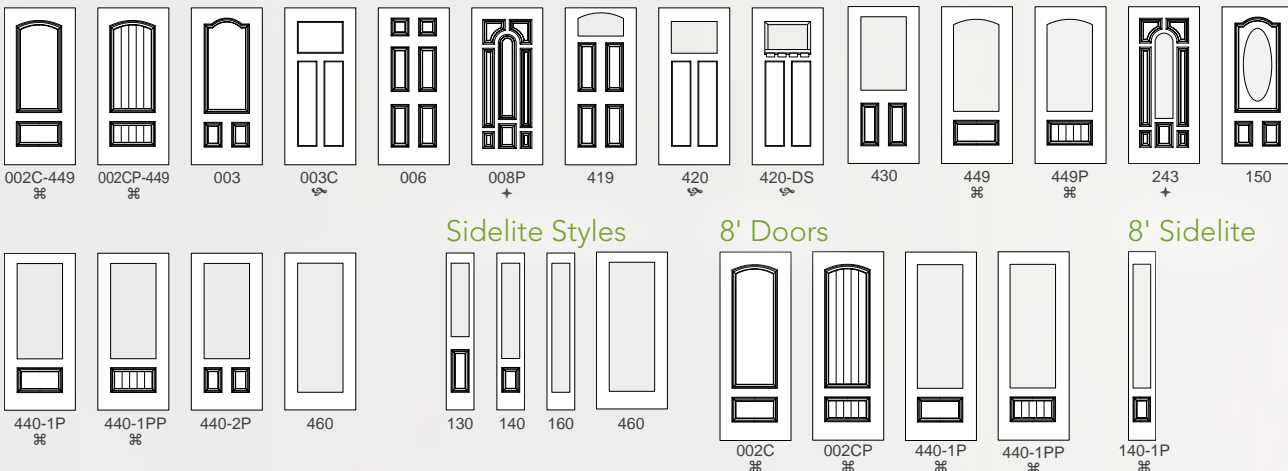

- ⌘ Signet Cherry Series Only
- + Signet Oak & Cherry Series only
- ⌘ Signet Fir Series Only

Entry System U-Factor: As low as .17  
(Tested to NFRC specifications for a 6 panel door with wood frame.)

# Signet Advantages



**Stiles and rails are dovetailed and glued** at each corner creating a structurally solid, integrated frame.



The **2 $\frac{5}{8}$ " finger-jointed 3-ply hardwood hinge stile** provides superior structural integrity.

ProVia doors are **foam filled by a computer driven process** that ensures the optimal foam fill for maximum efficiency and strength.



The **4 $\frac{1}{4}$ " finger-jointed 4-ply hardwood strike stile** provides a solid mounting surface for decorative hardware and superior structural integrity.

**The authentic wood look** is made possible by using cutting-edge nickel vapor deposition technology.

**Scientifically formulated compounds** provide superior resistance to denting, splitting, cracking, and warping.

**High-definition panel profile** creates excellent shadow lines and distinct panel designs.

The revolutionary **DuraFuse Finishing System featuring P<sup>3</sup> Fusion** yields unprecedented finish durability.

**Door edge** is constructed with cherry, mahogany, oak or fir wood matching the selected series.

**A high-performance, composite material** is utilized on all Signet fiberglass bottom rails, giving excellent rot-resistance.

Signet fiberglass entry systems come standard with an **anodized bronze threshold with a complementary riser**.

The inside door **frame is hand stained or painted to match your door** providing you with a consistent visual appearance. (Signet doors are also available with a Steel L-frame)

**NEW!**  
for 2012



**NEW Simulated Divided Lites for Signet Fiberglass Doors.** See pg. 57 for details.

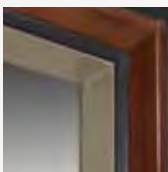

Signet Construction

# Heritage Fiberglass

Heritage Fiberglass doors feature enhanced woodgrain texture, improved definition embossing and a hardwood edge to prevent warping.

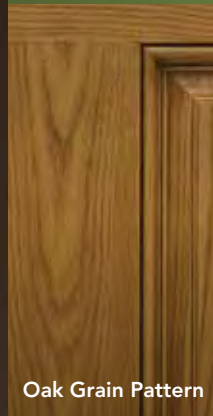

Oak Grain Pattern

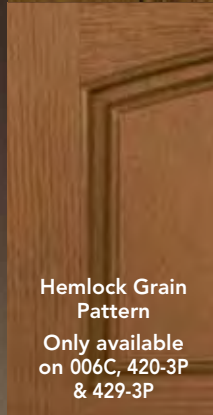

Hemlock Grain Pattern  
Only available on 006C, 420-3P & 429-3P



See page 65 for Heritage Fiberglass paint and stain finishes

\* Warranty time period may be limited in extreme exposure applications. See warranty for details.

Custom Heights Available.



Most Heritage Fiberglass Entry Systems are ENERGY STAR Qualified.

## Heritage Fiberglass Door Styles See pages 14-59 for glass availability.

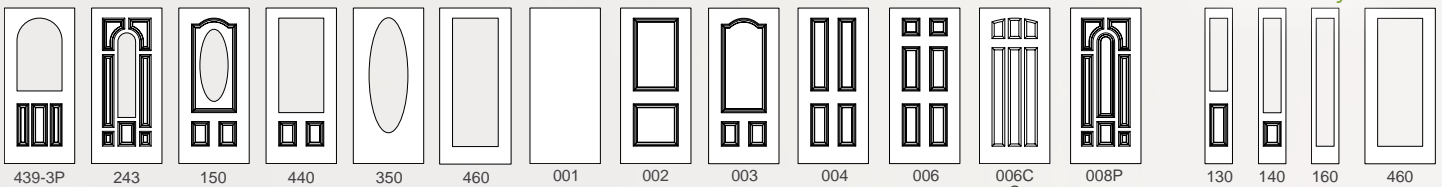
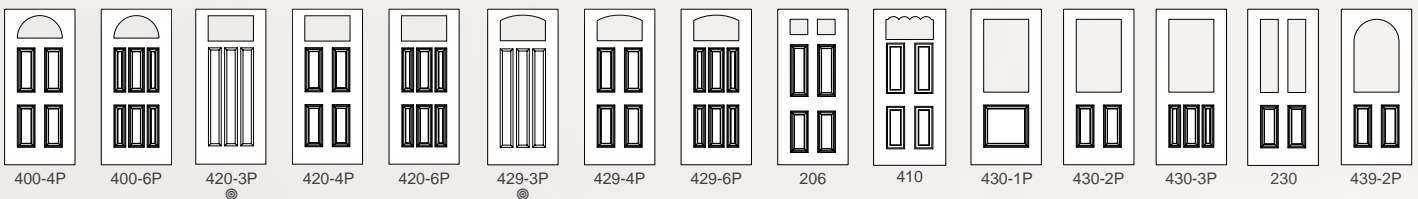

### Sidelite Styles

### 8' Doors

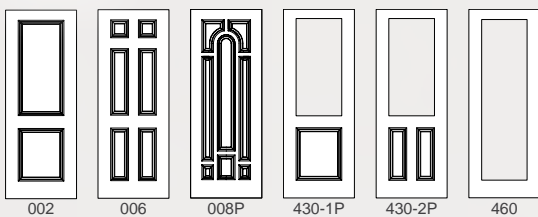

### 8' Sidelites

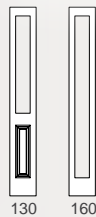

● Hemlock Grain Pattern Only

Entry System U-Factor: As low as .14  
(Tested to NFRC specifications for a 6 panel door with wood frame.)

# Heritage Advantages

**1 7/8" Finger-jointed, 2-ply solid oak laminated stiles** are locally manufactured exclusively for ProVia Door for both hinge and strike sides and are proven to provide increased rigidity and structural integrity.

**Polyurethane core** reduces energy loss.

**Improved definition panel profile** creates excellent shadow lines and distinct panel designs.

**Lock area is reinforced** to provide a solid mounting surface for decorative hardware.

**Specially engineered fiberglass door facings** will not dent and resist splitting, cracking and warping.

**Variable-depth woodgrain texture with hand-applied stain** imitates a wood door appearance.

**Square-edge design** offers an attractive wood door appearance.

**A high-performance, composite material** is utilized on all Heritage fiberglass bottom rails, giving excellent rot-resistance.

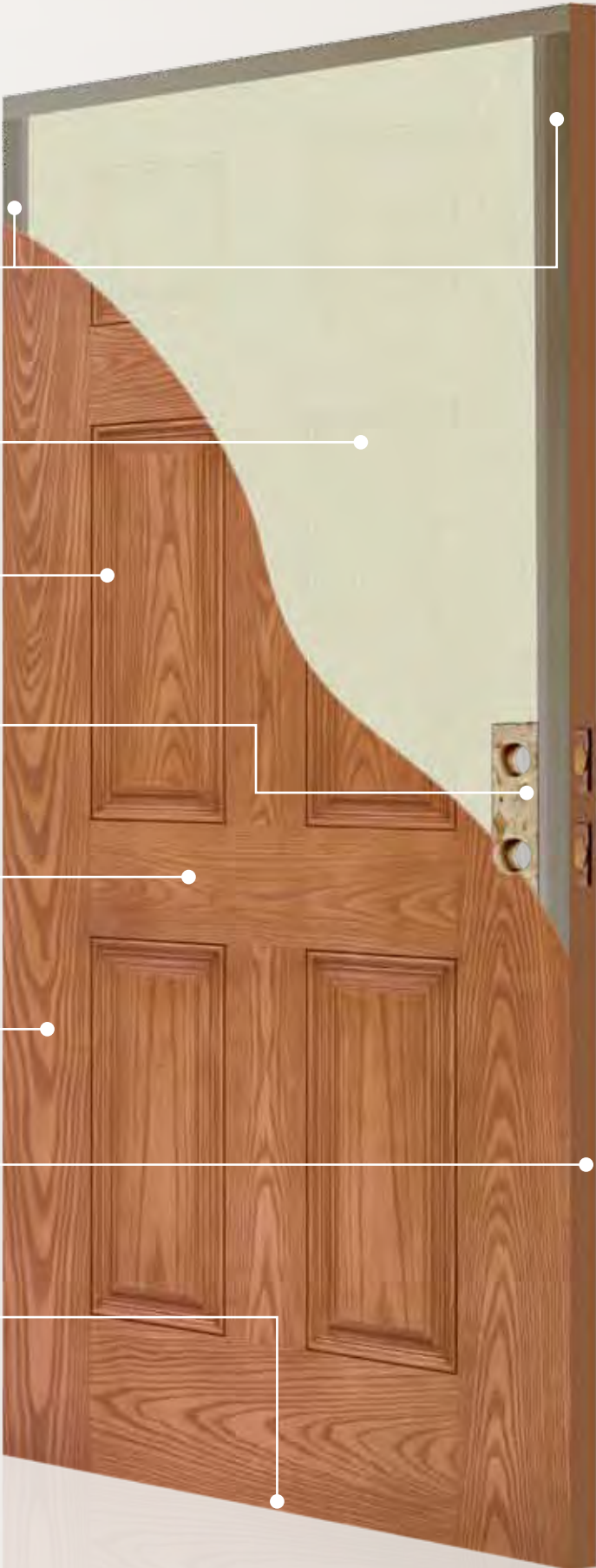

# Legacy Steel™

Legacy Steel features add up to a professional-class product. Whether you select Legacy Woodgrain Textured Steel or Smooth Steel, our entry systems will provide an elegant, durable and energy efficient addition to any home.



You can customize your 20-gauge entry door by ordering different styles and finishes on each side of your door.

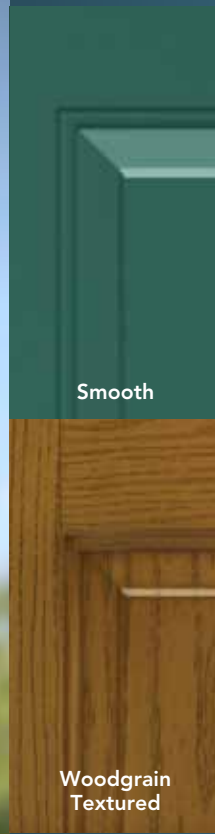

Smooth

Woodgrain Textured

### Custom Widths & Heights.

Need a little more height or a little less width? We are pleased to offer customized door widths and heights in 1/8" increments.



See page 65 for Legacy Steel paint and stain finishes

\* Warranty time period may be limited in extreme exposure applications. See warranty for details.



Most Legacy Steel Entry Systems are ENERGY STAR Qualified.

## Legacy Steel Door Styles See pages 14-59 for glass availability.

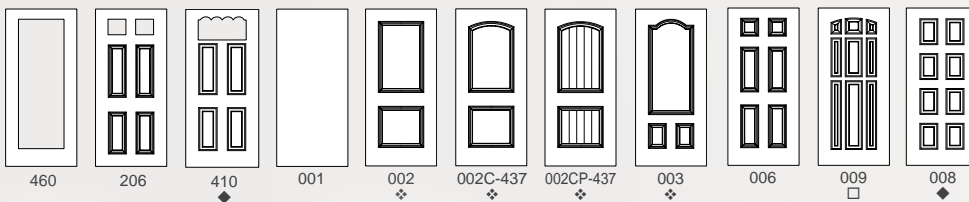

### Sidelite Styles

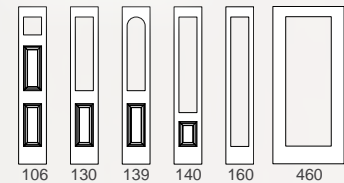

### 8' Doors

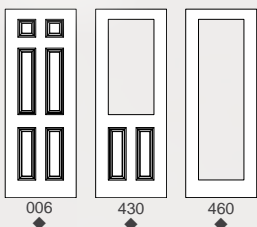

### 8' Sidelites

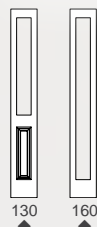

- Not available in 20-gauge Woodgrain Textured Steel
- ◆ Available in Smooth Steel only
- ◇ Only available in Smooth Steel with High-Definition Embossing

Entry System U-Factor: As low as .17  
(Tested to NFRC specifications for a 6 panel door with wood frame.)

# Legacy Advantages

**Composite top and bottom endcaps** increase rigidity and energy efficiency.

The edges and face skin of our steel doors are **one continuous piece of steel** for strength and durability.



**Special adhesives/thermal barrier** reduce heat and cold transfer, while our exclusive tab and slot system of **mechanical interlocks** gives the door exceptional structural strength.

ProVia doors are **foam filled by a computer driven process** that ensures the optimal foam fill for maximum energy efficiency and strength.

To reinforce the lock and deadbolt area, we add a **rigid composite lock block** to all of our steel doors.

Our 20-gauge steel doors give you **49% more galvanized steel** than a standard 24-gauge door.

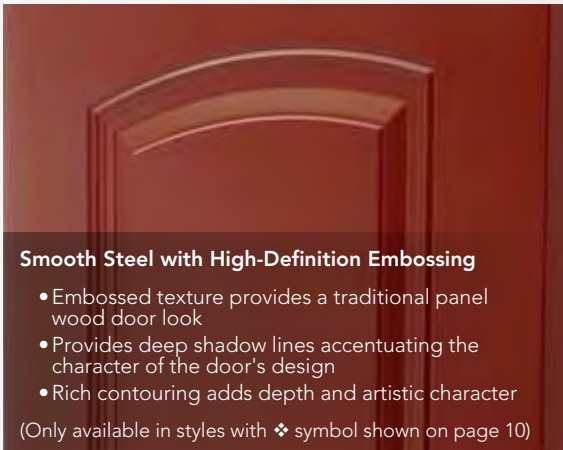

### Smooth Steel with High-Definition Embossing

- Embossed texture provides a traditional panel wood door look
- Provides deep shadow lines accentuating the character of the door's design
- Rich contouring adds depth and artistic character

(Only available in styles with ❖ symbol shown on page 10)

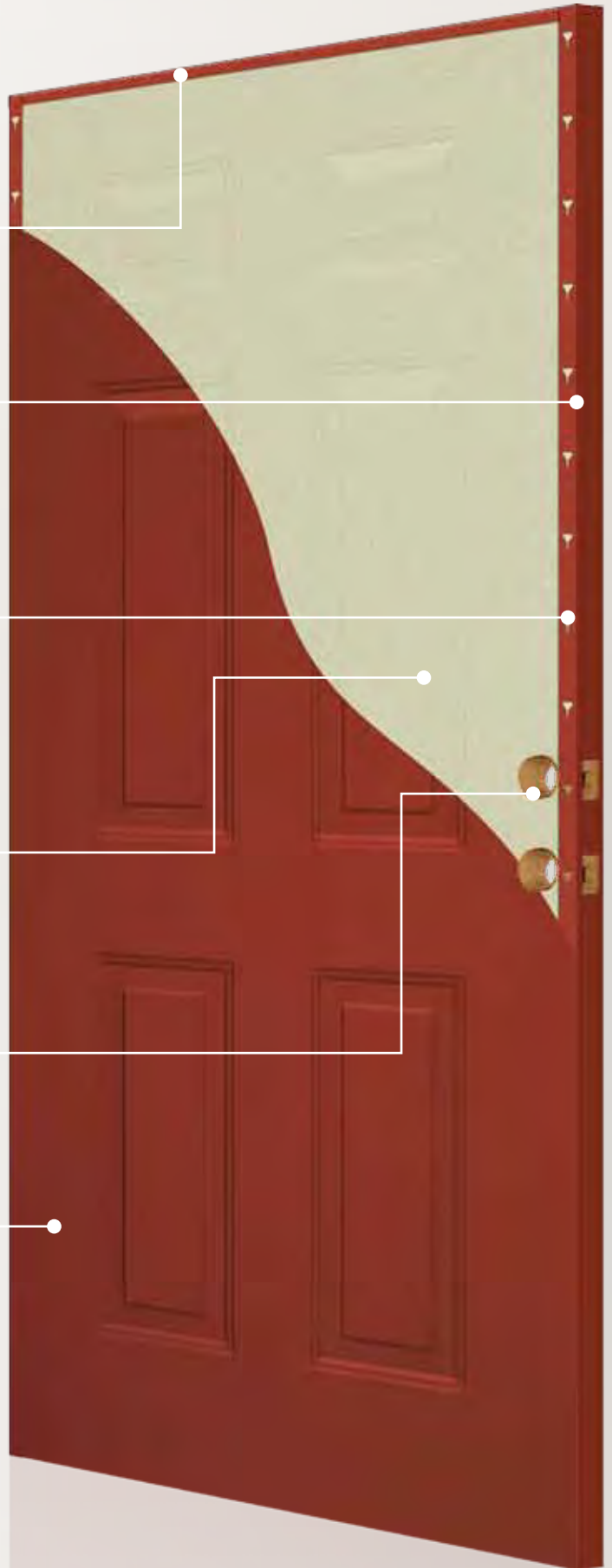

# ComforTech<sup>TM</sup> glass



Look for this symbol throughout this catalog indicating **ComforTech Warm Edge Glazing Systems.**

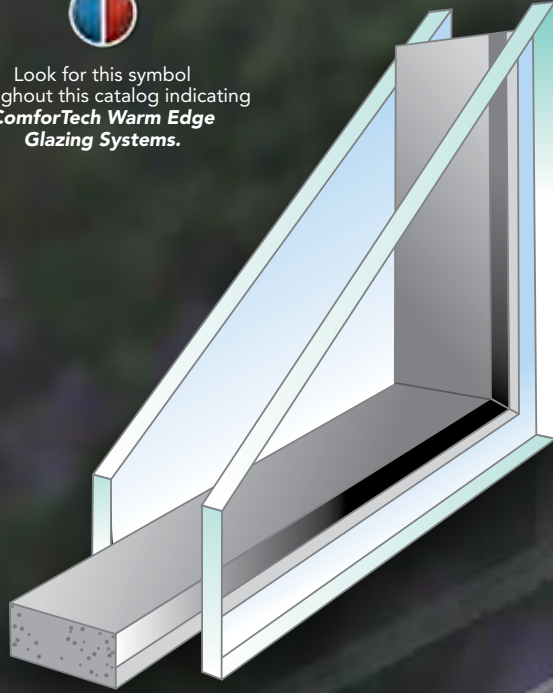

Measurably improve thermal performance with our ComforTech warm edge glazing system. You'll enjoy better energy efficiency and a warmer glass edge.

## ComforTech Warm Edge Glazing System is Included in all:

- Cheyenne, Brilliance, Barcelona, Tranquility & Twilight Decorative Glass
- Inspirations Art Glass
- Privacy Glass
- Clear Glass
- Internal & External Grids
- Designer Patio Doors
- Prestige<sup>TM</sup> Vinyl Sliding Patio Doors
- Vinyl Replacement Windows

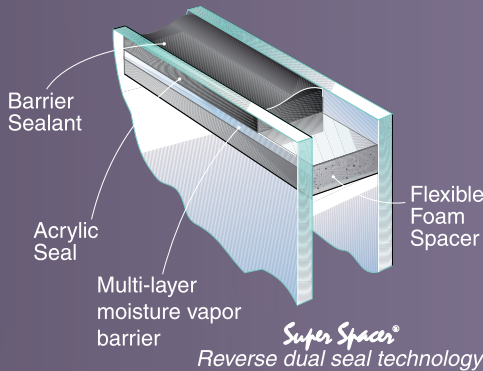

# ComforTech™ Advantages

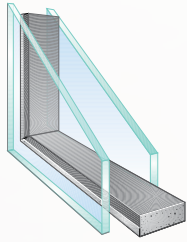

The NO-Metal Advantage

“Thermal efficiency through no presence of conductive metals” is the Super Spacer® hallmark.

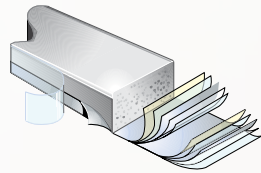

Mylar 10-Layer Vapor Barrier

The Super Spacer® thermoset foam matrix is exceptional. Moisture is kept out, gas is kept in and conductivity is virtually nonexistent.

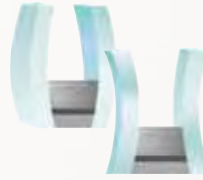

Withstands Normal Bowing

The design of our Warm Edge Glazing System stands up to the bending and bowing that is natural in any glass unit.



Enhanced Noise Reduction

Our all-foam formula's excellent sound-dampening properties reduce outside noise, even in industrial environments.

## Glazing System Options

### ComforTech™ TLK

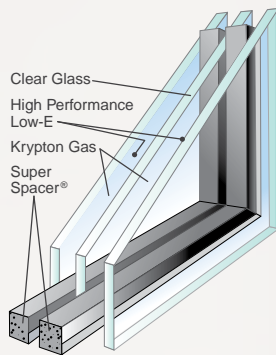

### ComforTech™ TLA

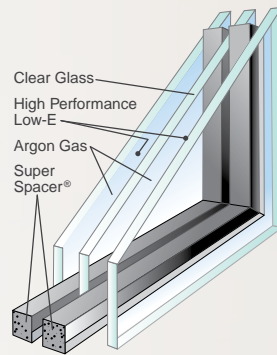

### ComforTech™ DLA

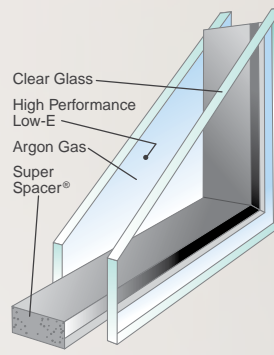

### ComforTech™ DC

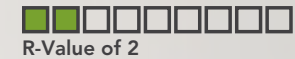
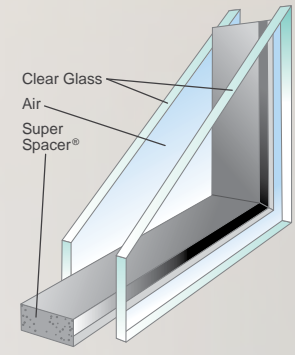

R-Value reflects properties of the glass only. Center of glass calculations are based upon software from Lawrence Berkeley National Laboratory.

<p><b>Standard Clear Insulated Glass</b></p>	<p>SOLAR HEAT GAIN COEFFICIENT = .76 (SHGC)</p>	<p>81%</p>	<p>59%</p>	<p>R-Value = 2</p>
	<p><b>COOLER IN SUMMER</b></p>	<p><b>Transmits Visible Light</b></p>	<p><b>Reduces Ultraviolet Energy</b></p>	<p><b>Warmer in Winter</b></p>
<p><b>LOW-E PPG Solarban®60 Insulated Glass</b></p>	<p>SOLAR HEAT GAIN COEFFICIENT = .38 (SHGC)</p>	<p>72%</p>	<p>21%</p>	<p>R-Value = 4</p>
	<p><b>COOLER IN SUMMER</b></p>	<p><b>Transmits Visible Light</b></p>	<p><b>Reduces Ultraviolet Energy</b></p>	<p><b>Warmer in Winter</b></p>



series

# Cheyenne



All Cheyenne Glass includes our **ComforTech Glazing System.**

Cheyenne features micro-granite, hammered and beveled glass that will add elegance to your entryway, while providing a high level of privacy for your home.



460CHP, 160CHP, 512/513CHP

## Cheyenne Styles

512/513CHP pg. 78



160CHP  
◆◆  
pg. 53

460CHP  
◆◆  
pg. 38

160CHP  
◆◆  
pg. 53



140CHP  
◆◆  
pg. 51

440CHP ◇  
◆◆  
pg. 30

140CHP  
◆◆  
pg. 51



350CHP  
○◆  
pg. 42

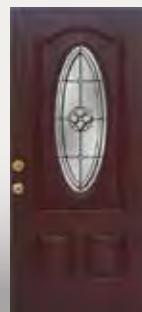

150CHP  
◆◆  
pg. 44



240CHP  
◆◆  
pg. 33



243CHP  
⊕○  
pg. 28

Caming

Micro-granite

Hammered

Faceted Jewel

Clear Beveled

Caming Finish Available

Patina

Zinc

Specify caming finish using the following codes:

Patina - CHP, Zinc - CHZ

Privacy Rating

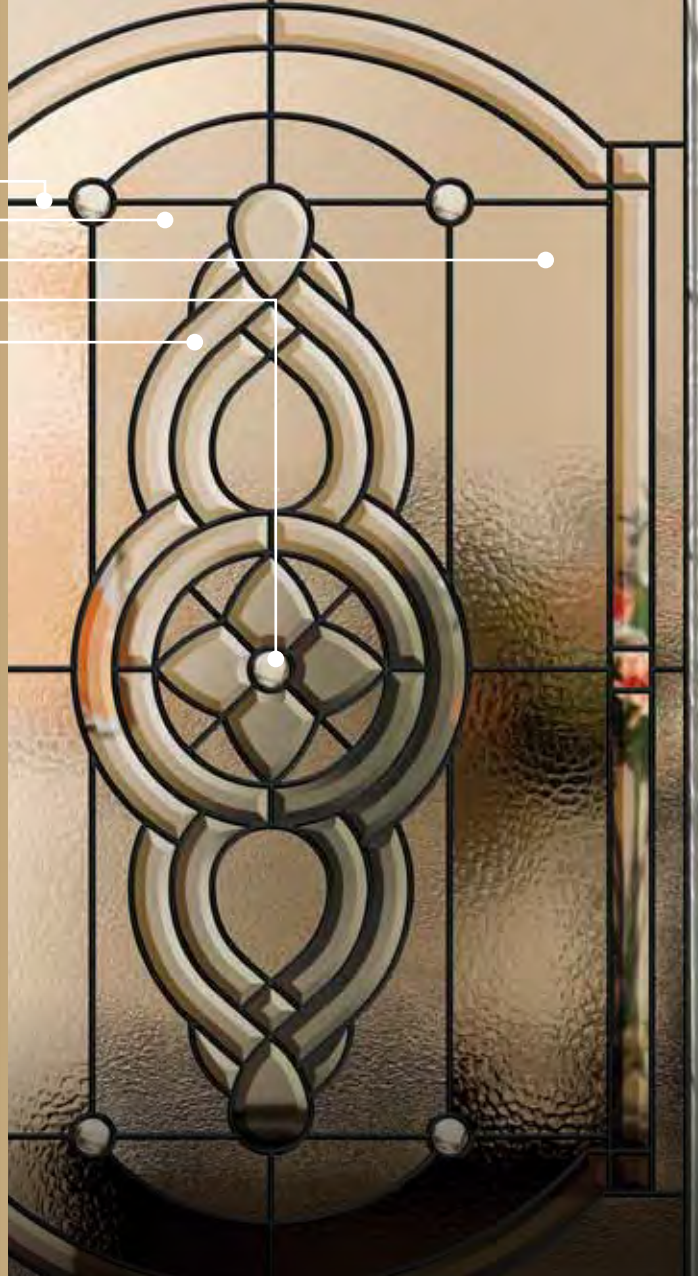
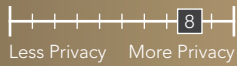

Cheyenne Glass



All Entry Systems using Cheyenne Glass are ENERGY STAR Qualified.

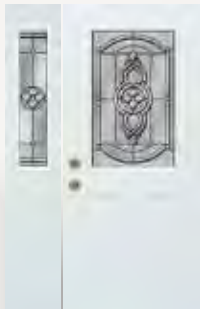

130CHP  
●◆  
pg. 49

430CHP ✦  
●◆◆  
pg. 16



230CHP  
○□◆  
pg. 20

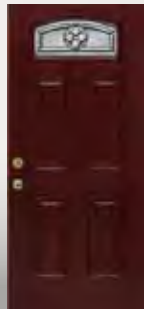

419CHP  
○  
pg. 11

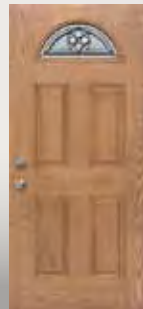

400CHP ✦  
○◆◆  
pg. 8



110CHP  
□◆  
pg. 15

- Signet and Heritage Fiberglass
- Signet Fiberglass
- ⊞ Signet Cherry Series Fiberglass
- + Signet Oak Series Fiberglass
- Heritage Fiberglass

- 20-gauge Woodgrain Textured Steel
- 22-gauge Woodgrain Textured Steel
- ◆ Smooth Steel
- ✦ For additional door panel styles see pg. 6 (for Signet) pg. 8 (Heritage) or pg. 10 (Legacy)



series

# Brilliance



All Brilliance Glass includes our **Comfortech Glazing System.**

Brilliance features micro-granite and hammered glass with artistic beveled glass detailing, and is sure to make a lasting impression.



460BRZ, 160BRZ, 512/513BRZ

## Brilliance Styles

512/513BRZ pg. 78

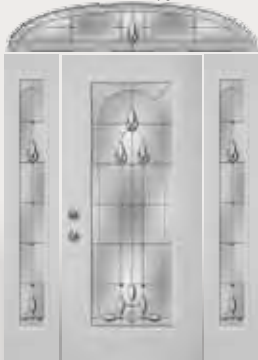

160BRZ  
◆◆  
pg. 53

460BRZ  
◆◆  
pg. 38

160BRZ  
◆◆  
pg. 53



140BRZ  
◆◆  
pg. 51

440BRZ ⇄  
◆◆  
pg. 30

140BRZ  
◆◆  
pg. 51



150BRZ  
◆◆  
pg. 44



240BRZ  
◆◆  
pg. 33



243BRZ  
⊕ + ○  
pg. 28

Caming

Micro-granite

Hammered

Clear Beveled

### Caming Finish Available

Patina

Zinc

Specify caming finish using the following codes:

Patina - BRP, Zinc - BRZ

### Privacy Rating

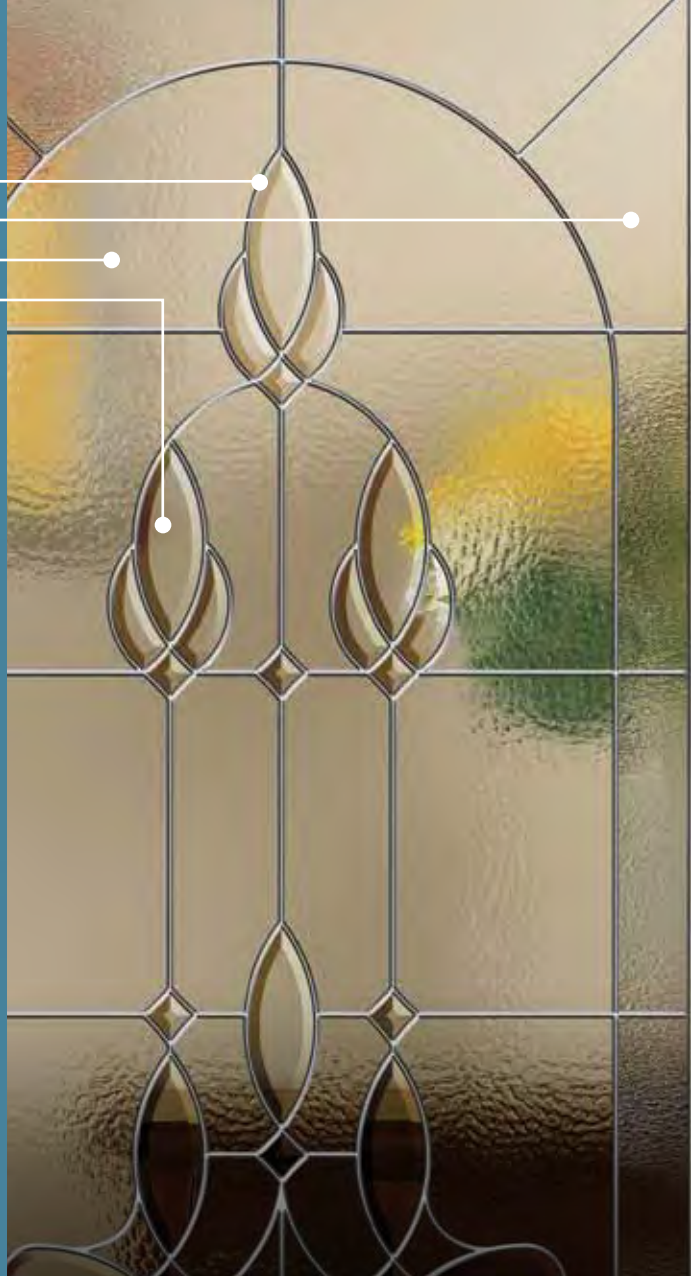

Brilliance Glass



All Entry Systems using Brilliance Glass are ENERGY STAR Qualified.



130BRZ ●◆ pg. 49    430BRZ ◆ pg. 16



230BRZ ○◆ pg. 20

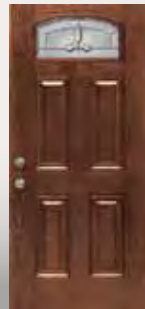

419BRZ ○ pg. 11



400BRZ ◆○ pg. 8

- Signet and Heritage Fiberglass
- Signet Fiberglass
- ⊞ Signet Cherry Series Fiberglass
- ⊕ Signet Oak Series Fiberglass
- Heritage Fiberglass

- 20-gauge Woodgrain Textured Steel
- 22-gauge Woodgrain Textured Steel
- ◆ Smooth Steel
- ◆ For additional door panel styles see pg. 6 (for Signet) pg. 8 (Heritage) or pg. 10 (Legacy)

# series Glenmore

Glenmore features a reflective bronze beveled glass that will show off your entry to a spectacular advantage. Striking and beautiful, it will make an unforgettable first impression.



460GLE, Custom Sized 532DLA

## Glenmore Styles

532GLE pg. 82



160GLE  
○◆◆  
pg. 53

460GLE  
◆◆◆  
pg. 38

160GLE  
○◆◆  
pg. 53



140GLE  
◆◆◆  
pg. 52

440GLE ⇄  
◆◆◆  
pg. 30

140GLE  
◆◆◆  
pg. 52



160GLE  
○◆◆  
pg. 53

350GLE  
○◆◆  
pg. 42

160GLE  
○◆◆  
pg. 53

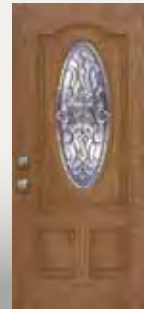

150GLE  
◆◆  
pg. 44

- Zinc Caming
- Gray Baroque
- Reflective Bronze Beveled

Caming Finish Available

Zinc

Privacy Rating

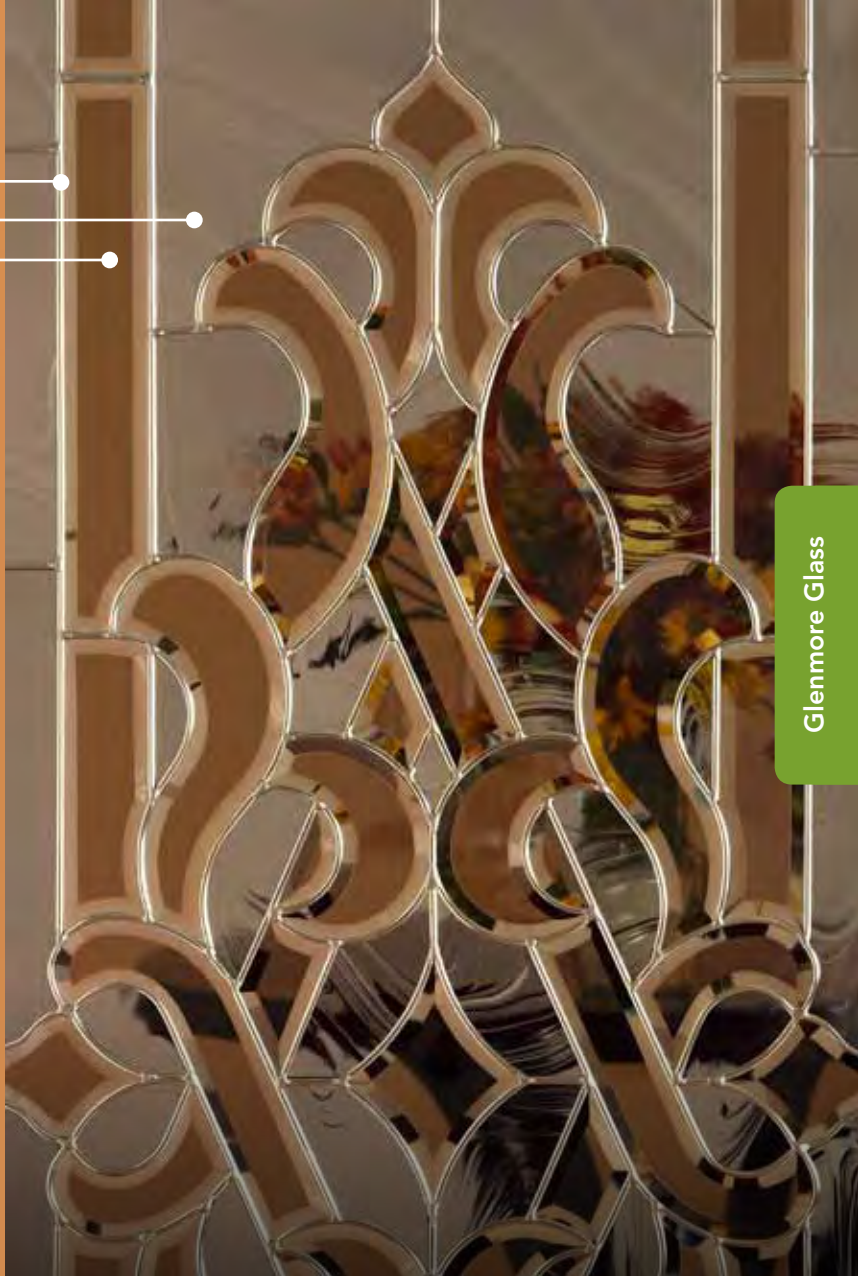
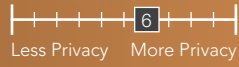

Glenmore Glass



All Entry Systems using Glenmore Glass are ENERGY STAR Qualified.



240GLE  
■◆  
pg. 34



243GLE  
⌘+○  
pg. 28



429GLE ⋄  
○  
pg. 14



400GLE ⋄  
○◆  
pg. 8

- Signet and Heritage Fiberglass
- ⌘ Signet Cherry Series Fiberglass
- + Signet Oak Series Fiberglass
- Heritage Fiberglass
- 20-gauge Woodgrain Textured Steel
- ◆ Smooth Steel
- ⋄ For additional door panel styles see pg. 6 (for Signet) pg. 8 (Heritage) or pg. 10 (Legacy)

# series St. Jane

St. Jane features beautiful traditional design with handcrafted beveled glass and brass, patina or zinc caming.



460STJ, 160STJ

## St. Jane Styles

532STJ‡ pg. 82



612/613STJ pg. 80



712/713STJ\*\* pg. 77



512/513STJ pg. 78



516STJ‡ pg. 82



160STJ  
◆◆  
pg. 53

460STJ  
◆◆  
pg. 38

160STJ  
◆◆  
pg. 53

140STJ  
◆◆  
pg. 52

440STJ ◊  
◆◆  
pg. 30

140STJ  
◆◆  
pg. 52

770STJ+§  
◆◆  
pg. 60

449STJ ◊  
⌘  
pg. 37

770STJ+§  
◆◆  
pg. 60

160STJ  
◆◆  
pg. 53

350STJ  
○◆◆  
pg. 42

160STJ  
◆◆  
pg. 53

150STJ  
◆◆  
pg. 44

240STJ  
◆◆  
pg. 34

Caming

Clear Baroque

Clear Beveled

Gray Baroque

Clear Water

### Caming Finish Available

Brass

Patina

Zinc

Specify caming finish using the following codes:  
Brass - STJ, Patina - STP, Zinc - STZ

### Privacy Rating

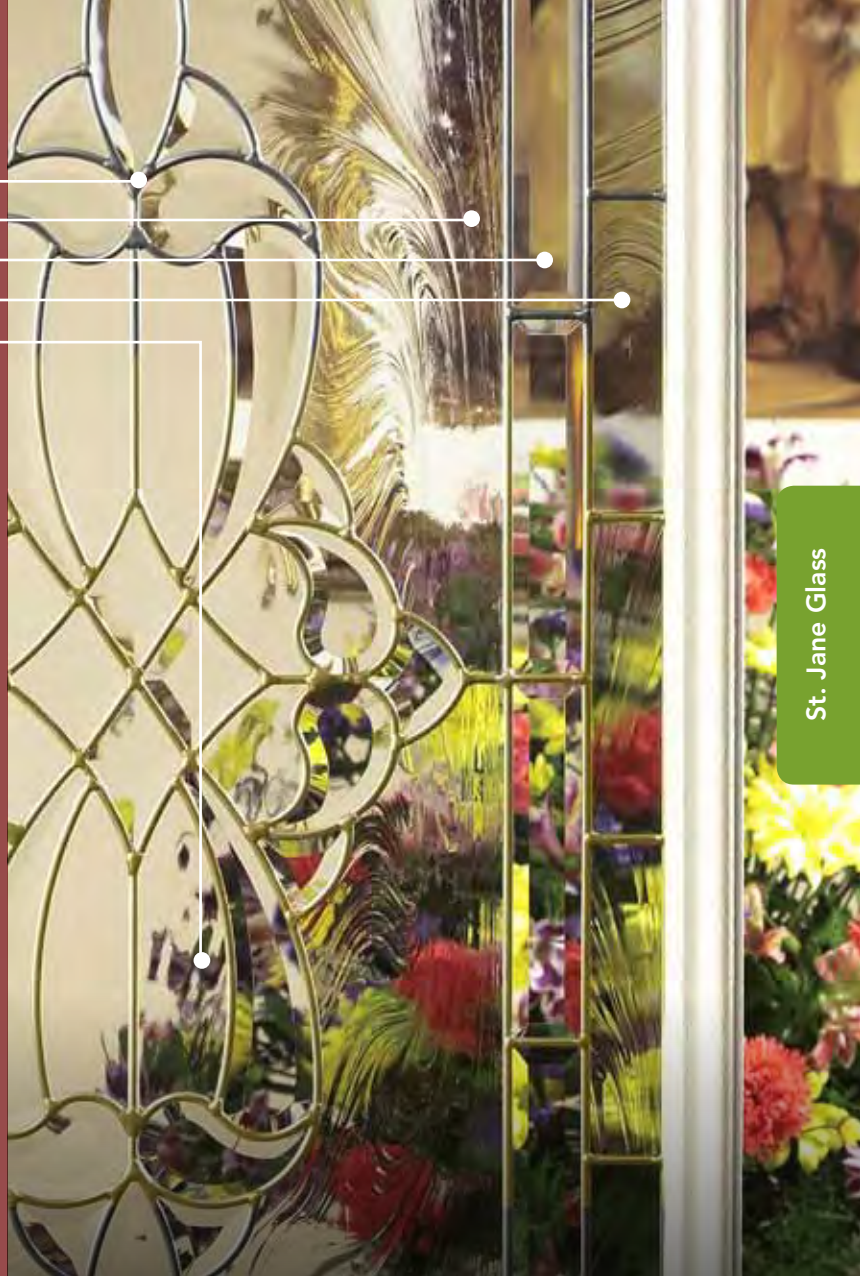
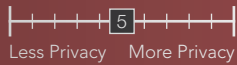

All Entry Systems using St. Jane Glass are ENERGY STAR Qualified.



243STJ  
⌘ + ○  
pg. 28

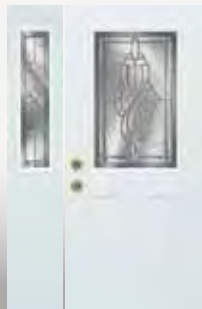

130STJ  
●◆◆  
pg. 49

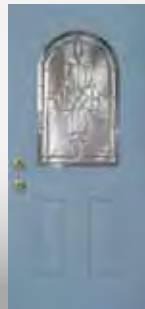

430STJ ⋄  
●◆◆  
pg. 16



439STJ ⋄ ‡  
○◆◆  
pg. 25

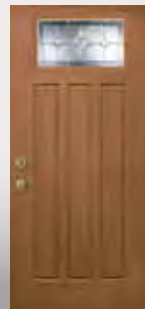

230STJ  
○□◆  
pg. 20



420STJ ⋄  
○  
pg. 12

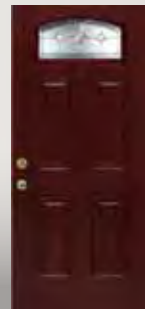

429STJ ⋄  
○  
pg. 14

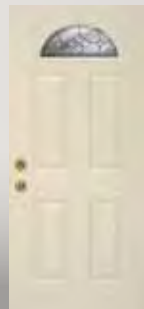

419STJ  
○  
pg. 11



400STJ ⋄  
○◆◆  
pg. 8



110STJ ‡  
□◆  
pg. 15

- Signet and Heritage Fiberglass
- Signet Fiberglass
- ⌘ Signet Cherry Series Fiberglass
- + Signet Oak Series Fiberglass
- Heritage Fiberglass

- 20-gauge Woodgrain Textured Steel
- 22-gauge Woodgrain Textured Steel
- ◆ Smooth Steel
- ‡ Not available in Zinc caming

- § Also available in 10" width. See Price List for design pattern
- \*\* Requires an additional 4-week lead time
- ⋄ For additional door panel styles see pg. 6 (for Signet) pg. 8 (Heritage) or pg. 10 (Legacy)

# Crystal series

Crystal expresses your elegant side in a design that makes excellent use of clear beveled glass and clear baroque glass. Eye catching and sophisticated your entry will make a statement that will impress everyone.



243CRS, 160CRS

## Crystal Styles

612/613CRS pg. 80			512/513CRS pg. 79			712/713CRS** pg. 77				
160CRS ◆◆ pg. 53	460CRS ◆◆ pg. 38	160CRS ◆◆ pg. 53	140CRS ◆◆ pg. 52	440CRS ◆◆ pg. 31	140CRS ◆◆ pg. 52	770CRS ◆◆ pg. 60	449CRS ◆◆ pg. 37	770CRS ◆◆ pg. 60	240CRS ◆◆ pg. 34	243CRS ◆◆+○ pg. 28

Zinc Caming

Clear Beveled

Baroque

Gray Baroque

Caming Finish Available

Zinc

Privacy Rating

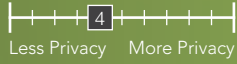

Crystal Glass



All Entry Systems using Crystal Glass are ENERGY STAR Qualified.

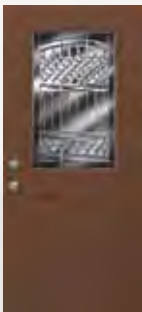

430CRS ◊  
●◆  
pg. 16



130CRS  
●◆  
pg. 49



230CRS  
○□◆  
pg. 20



130CRS  
●◆  
pg. 49

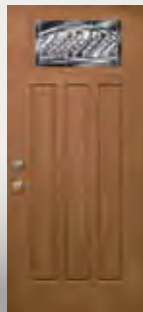

420CRS ◊  
○  
pg. 12

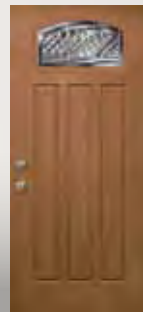

429CRS ◊  
○  
pg. 14

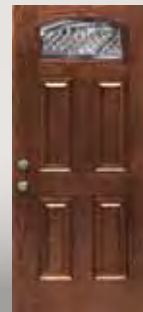

419CRS  
○  
pg. 11

- Signet and Heritage Fiberglass
- Signet Fiberglass
- ⌘ Signet Cherry Series Fiberglass
- + Signet Oak Series Fiberglass
- Heritage Fiberglass

- 20-gauge Woodgrain Textured Steel
- 22-gauge Woodgrain Textured Steel
- ◆ Smooth Steel
- \*\* Requires an additional 4-week lead time
- ◊ For additional door panel styles see pg. 6 (for Signet) pg. 8 (Heritage) or pg. 10 (Legacy)

# series Santa Fe

Santa Fe features the artistry associated with the Arts and Crafts period. The distinctive southwestern-inspired geometric symmetry adds visual interest to any home.



420SAN, 160SAN

## Santa Fe Styles

612/613SAN pg. 80



160SAN  
◆◆  
pg. 53

460SAN  
◆◆◆  
pg. 38

160SAN  
◆◆◆  
pg. 53

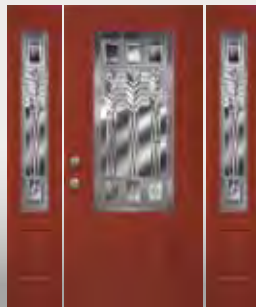

140SAN  
◆◆◆  
pg. 52

440SAN ◀  
◆◆◆  
pg. 31

140SAN  
◆◆◆  
pg. 52



240SAN  
◆◆  
pg. 34



130SAN  
◆◆◆  
pg. 49

430SAN ◊  
◆◆◆  
pg. 16



230SAN  
○□◆  
pg. 21

- Zinc Caming
- Clear Beveled
- Ribbed
- Granite
- Seedy

**Caming Finish Available**

Zinc

**Privacy Rating**

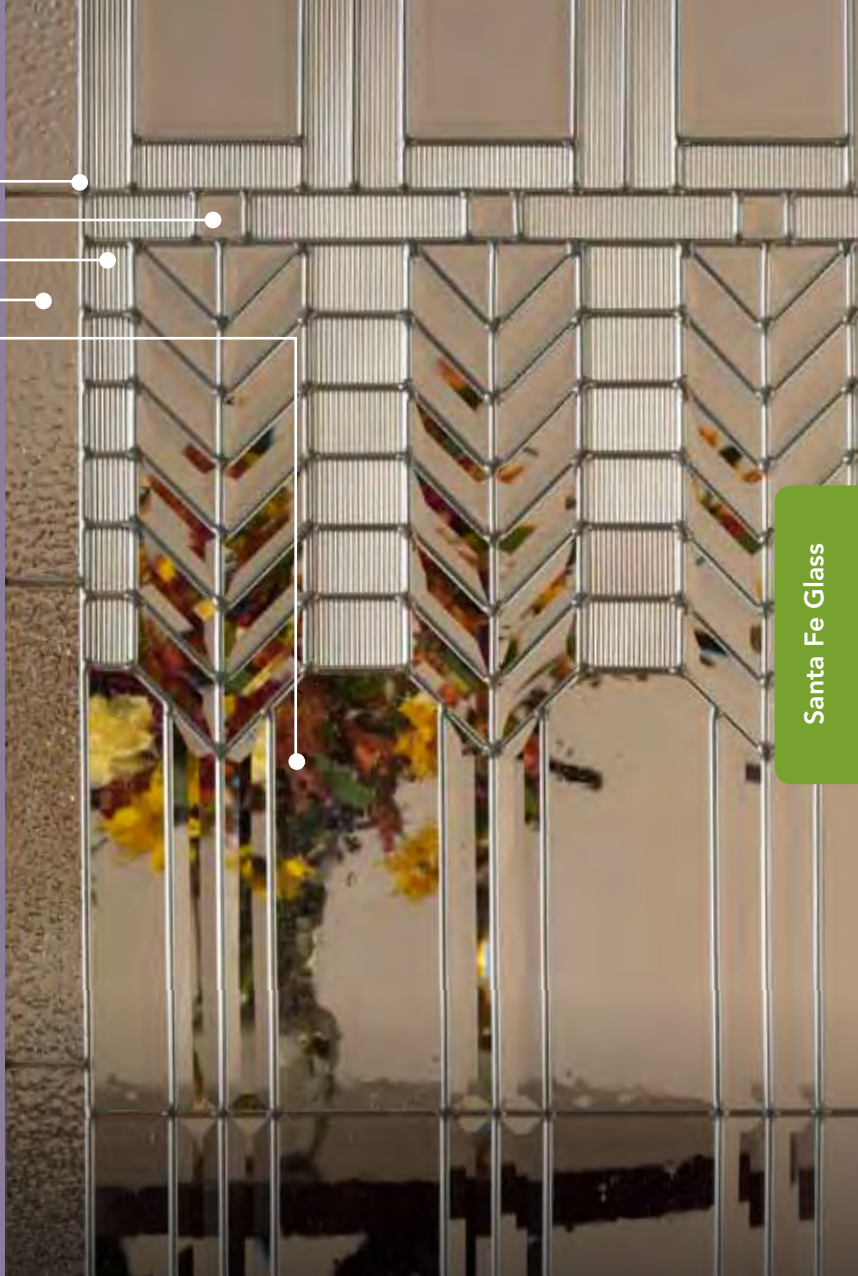
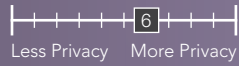

Santa Fe Glass



All Entry Systems using Santa Fe Glass are ENERGY STAR Qualified.



243SAN  
☼ + ○  
pg. 28



160SAN  
pg. 53

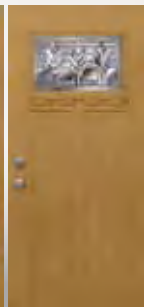

420SAN-DS ✧  
pg. 12



160SAN  
pg. 53

- Signet and Heritage Fiberglass
- ☼ Signet Cherry Series Fiberglass
- + Signet Oak Series Fiberglass
- ☼ Signet Fir Series Fiberglass
- Heritage Fiberglass
- 20-gauge Woodgrain Textured Steel
- 22-gauge Woodgrain Textured Steel
- ◆ Smooth Steel
- ✧ For additional door panel styles see pg. 6 (for Signet) pg. 8 (Heritage) or pg. 10 (Legacy)

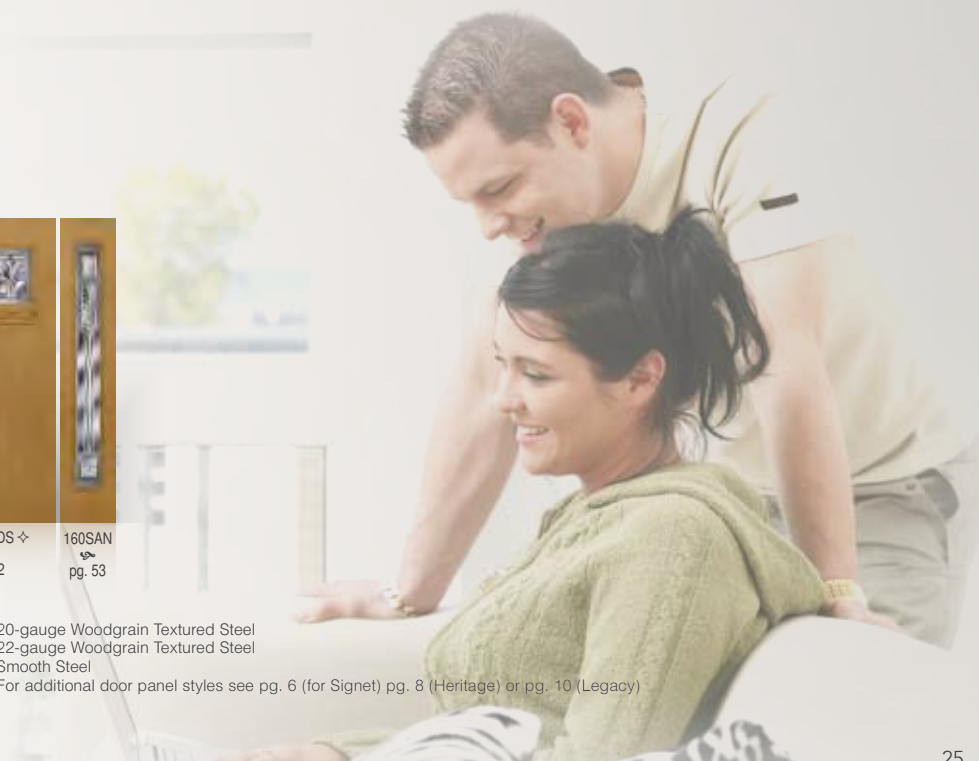

# Solitaire

series

Solitaire features an elegant design of handcut clear beveled glass surrounded by the privacy of gluechip glass in zinc coming.



460SOL

## Solitaire Styles

612/613SOL pg. 80			712/713SOL** pg. 77									
160SOL ◆◆ pg. 53	460SOL ◆◆ pg. 38	160SOL ◆◆ pg. 53	140SOL ◆◆ pg. 52	440SOL ⇄ ◆◆ pg. 31	140SOL ◆◆ pg. 52	770SOL§ ◆◆ pg. 60	449SOL ⇄ ⌘ pg. 37	770SOL§ ◆◆ pg. 60	350SOL ○◆ pg. 42	150SOL ◆◆ pg. 44	240SOL ◆◆ pg. 34	243SOL ⌘ + ○ pg. 28

Zinc Caming

Clear Beveled

Granite

Gluechip

Beveled Jewel

Caming Finish Available

Zinc

Privacy Rating

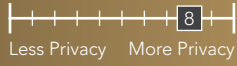

Solitaire Glass



All Entry Systems using Solitaire Glass are ENERGY STAR Qualified.



439SOL  
○◆◆  
pg. 25

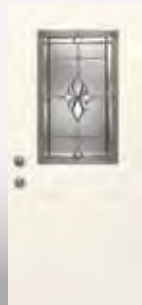

430SOL  
●◆◆  
pg. 17



139SOL  
■◆  
pg. 51

239SOL  
◆  
pg. 27



130SOL  
●◆◆  
pg. 49

230SOL  
○□◆  
pg. 21

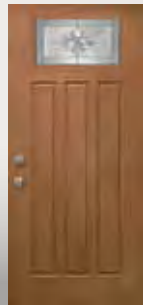

420SOL  
○  
pg. 12

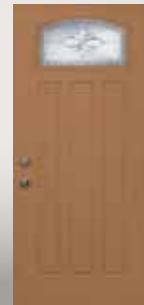

429SOL  
○  
pg. 14

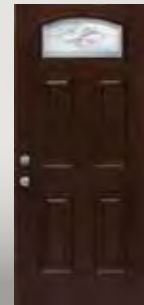

419SOL  
○◆  
pg. 11



400SOL  
○◆◆  
pg. 8



110SOL  
□◆  
pg. 15

- Signet and Heritage Fiberglass
- Signet Fiberglass
- ⊗ Signet Cherry Series Fiberglass
- + Signet Oak Series Fiberglass

- Heritage Fiberglass
- 20-gauge Woodgrain Textured Steel
- 22-gauge Woodgrain Textured Steel
- ◆ Smooth Steel

- § Also available in 10" width. See Price List for design pattern
- \*\* Requires an additional 4-week lead time
- ◇ For additional door panel styles see pg. 6 (for Signet) pg. 8 (Heritage) or pg. 10 (Legacy)



series

# Barcelona



All Barcelona Glass includes **ComforTech DLA High Performance Low-E Argon Glass.**

Barcelona features an exquisite wrought iron design with the option of choosing gluechip (standard), waterfall, taffeta, chinchilla, obscure pebble, or clear glass.



460BRC, 160BRC

## Barcelona Styles



All Entry Systems using Barcelona Glass are ENERGY STAR Qualified.

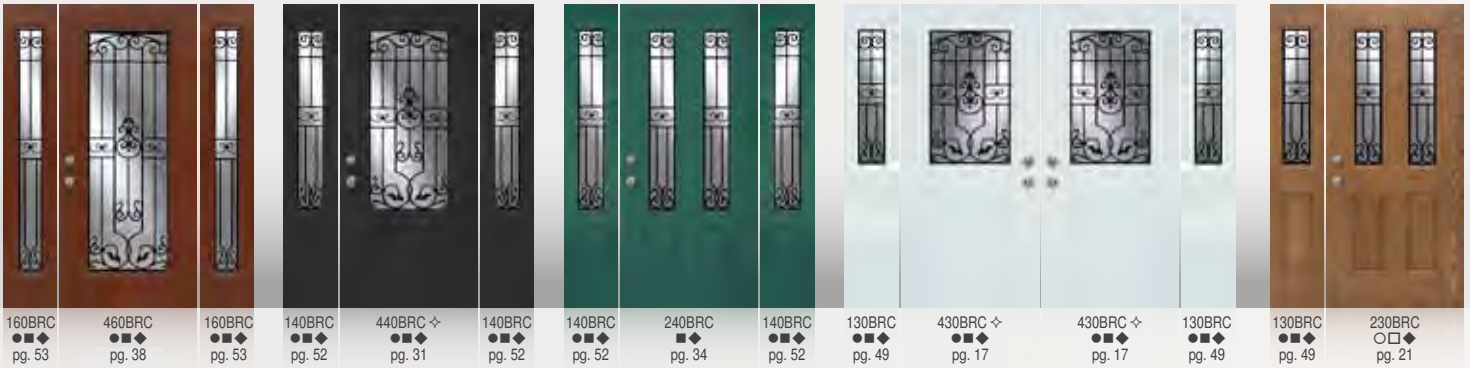

160BRC  
●◆  
pg. 53

460BRC  
●◆  
pg. 38

160BRC  
●◆  
pg. 53

140BRC  
●◆  
pg. 52

440BRC ⇄  
●◆  
pg. 31

140BRC  
●◆  
pg. 52

140BRC  
●◆  
pg. 52

240BRC  
■◆  
pg. 34

140BRC  
●◆  
pg. 52

130BRC  
●◆  
pg. 49

430BRC ⇄  
●◆  
pg. 17

430BRC ⇄  
●◆  
pg. 17

130BRC  
●◆  
pg. 49

130BRC  
●◆  
pg. 49

230BRC  
○□◆  
pg. 21

- Signet and Heritage Fiberglass
- Heritage Fiberglass
- 20-gauge Woodgrain Textured Steel
- 22-gauge Woodgrain Textured Steel

- ◆ Smooth Steel
- ⇄ For additional door panel styles see pg. 6 (for Signet) pg. 8 (Heritage) or pg. 10 (Legacy)

Gluechip

Privacy Rating

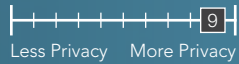

Barcelona Glass

When you order Barcelona glass using the style code BRC, you will receive the standard Gluechip glass. To order the other Privacy Glass options shown below, use the style codes CHI, TAF, WAT and OBS after the letters BRC (ie. 460BRC-CHI).

Chinchilla



Privacy Rating

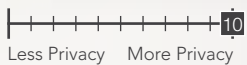

Taffeta



Privacy Rating

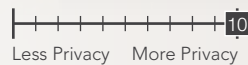

Waterfall



Privacy Rating

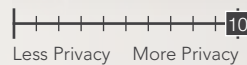

Obscure



Privacy Rating

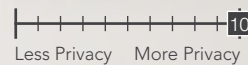

# series Radiant Hues

Radiant Hues features clear and gray baroque glass with beveled glass and zinc caming in a unique design that will accent your home beautifully.



460RAD, 160RAD

## Radiant Hues Styles



All Entry Systems using Radiant Hues Glass are ENERGY STAR Qualified.

612/613RAD pg. 80



160RAD  
●◆ pg. 54

460RAD  
●◆ pg. 39

160RAD  
●◆ pg. 54



243RAD  
⌘+○ pg. 29



130RAD  
●◆ pg. 49

430RAD  
●◆◇ pg. 17

130RAD  
●◆ pg. 49



230RAD  
○□◆ pg. 21



400RAD  
○◆◇ pg. 9

- Signet and Heritage Fiberglass
- ⌘ Signet Cherry Series Fiberglass
- Heritage Fiberglass
- + Signet Oak Series Fiberglass

- 20-gauge Woodgrain Textured Steel
- 22-gauge Woodgrain Textured Steel
- ◆ Smooth Steel
- ◇ For additional door panel styles see pg. 6 (for Signet) pg. 8 (Heritage) or pg. 10 (Legacy)

- Zinc Caming
- Clear Beveled
- Clear Baroque
- Gray Baroque
- Multi-facet Jewel

Caming Finish Available

Zinc

Privacy Rating

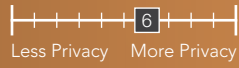

Radiant Hues Glass





series



All Tranquility Glass includes our **ComforTech Glazing System.**

**NEW!**  
for 2012

# Tranquility

Tranquility features unique Chinchilla glass accented with beveled clusters and streamed glass.



460TRP, 160TRP, 612/613TRP

## Tranquility Styles

612/613TRP pg. 77



160TRP  
◆◆  
pg. 53

460TRP  
◆◆  
pg. 38

160TRP  
◆◆  
pg. 53



140TRP  
◆◆  
pg. 51

440TRP <-  
◆◆  
pg. 31

140TRP  
◆◆  
pg. 51

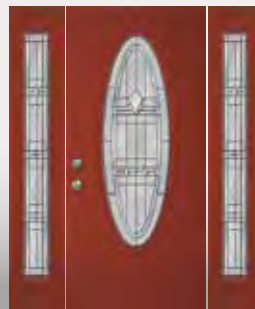

160TRP  
◆◆  
pg. 53

350TRP  
○◆◆  
pg. 42

160TRP  
◆◆  
pg. 53

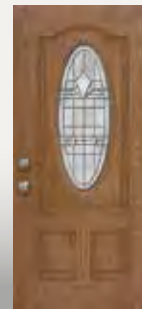

150TRP  
◆◆  
pg. 44



243TRP  
⌘ + ○  
pg. 28

Caming

Clear Beveled

Chinchilla

Streamed

Granite

### Caming Finish Available

Patina

Zinc

Specify caming finish using the following codes:

Patina - TRP, Zinc - TRZ

### Privacy Rating



Tranquility Glass



All Entry Systems using Tranquility Glass are ENERGY STAR Qualified.



240TRP  
◆◆  
pg. 33



130TRP  
◆◆◆  
pg. 49

430TRP ◆  
◆◆◆  
pg. 16



230TRP  
○□◆  
pg. 20

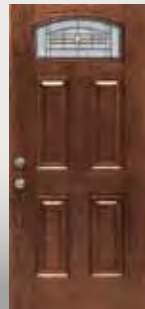

419TRP  
○  
pg. 11

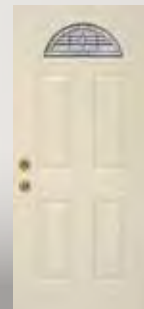

400TRP ◆  
○◆◆  
pg. 8



110TRP  
□◆  
pg. 15

- Signet and Heritage Fiberglass
- Signet Fiberglass
- ⊗ Signet Cherry Series Fiberglass
- + Signet Oak Series Fiberglass
- Heritage Fiberglass
- 20-gauge Woodgrain Textured Steel
- 22-gauge Woodgrain Textured Steel
- ◆ Smooth Steel

# Classic series

Design and value make the Classic series a popular addition to any style door. The beauty of this design is simple, yet it makes a tasteful statement.



440CLA, 160CLA, Custom Sized 612/613CLA

## Classic Styles



- Brass Caming
- Gluechip
- Clear Glass
- Clear Beveled

Caming Finish Available



Privacy Rating

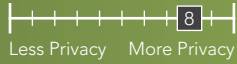

Classic Glass



All Entry Systems using Classic Glass are ENERGY STAR Qualified.

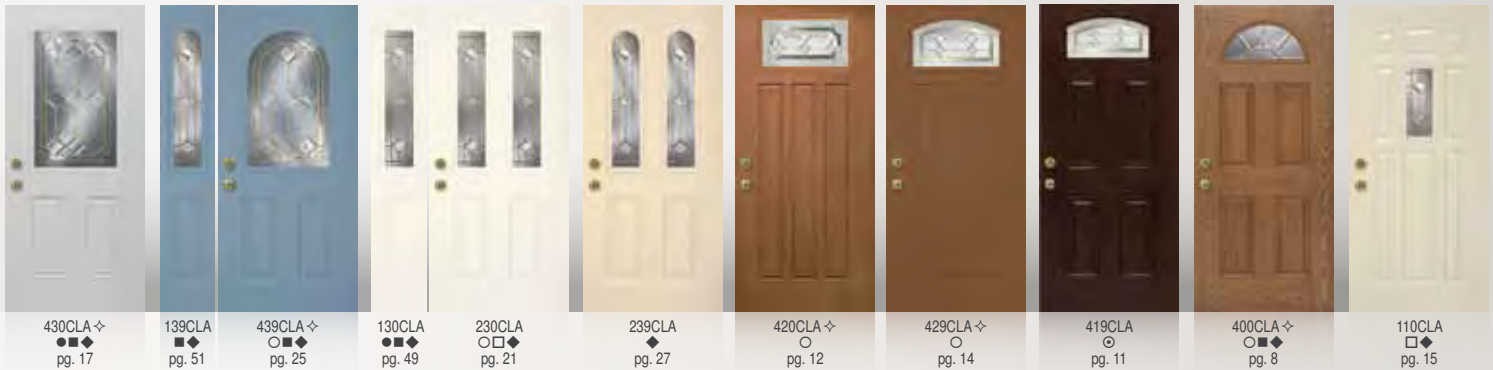

430CLA ◊ ■ ■ ◆ pg. 17	139CLA ■ ◆ pg. 51	439CLA ◊ ○ ◆ pg. 25	130CLA ■ ◆ pg. 49	230CLA ○ □ ◆ pg. 21	239CLA ◆ pg. 27	420CLA ◊ ○ pg. 12	429CLA ◊ ○ pg. 14	419CLA ○ pg. 11	400CLA ◊ ○ ◆ pg. 8	110CLA □ ◆ pg. 15
-----------------------------	-------------------------	---------------------------	-------------------------	---------------------------	-----------------------	-------------------------	-------------------------	-----------------------	--------------------------	-------------------------

- Heritage Fiberglass
- 20-gauge Woodgrain Textured Steel
- 22-gauge Woodgrain Textured Steel
- ◆ Smooth Steel

- \*\* Requires an additional 4-week lead time
- ◊ For additional door panel styles see pg. 6 (for Signet) pg. 8 (Heritage) or pg. 10 (Legacy)

# Lehigh series

Lehigh creates an elegant charm using clear bevel designs and beautiful patina coming.



460LEH, 160LEH, 612/613LEH

## Lehigh Styles

612/613LEH pg. 90



160LEH ●◆ pg. 53  
460LEH ●◆ pg. 39  
160LEH ●◆ pg. 53



440LEH ◇●◆ pg. 31  
440LEH ◇●◆ pg. 31



140LEH ●◆ pg. 52  
240LEH ●◆ pg. 34  
140LEH ●◆ pg. 52



130LEH ●◆ pg. 49  
430LEH ◇●◆ pg. 17  
130LEH ●◆ pg. 49

Patina Caming

Clear Beveled

Ribbed

Granite

Caming Finish Available

Patina

Privacy Rating

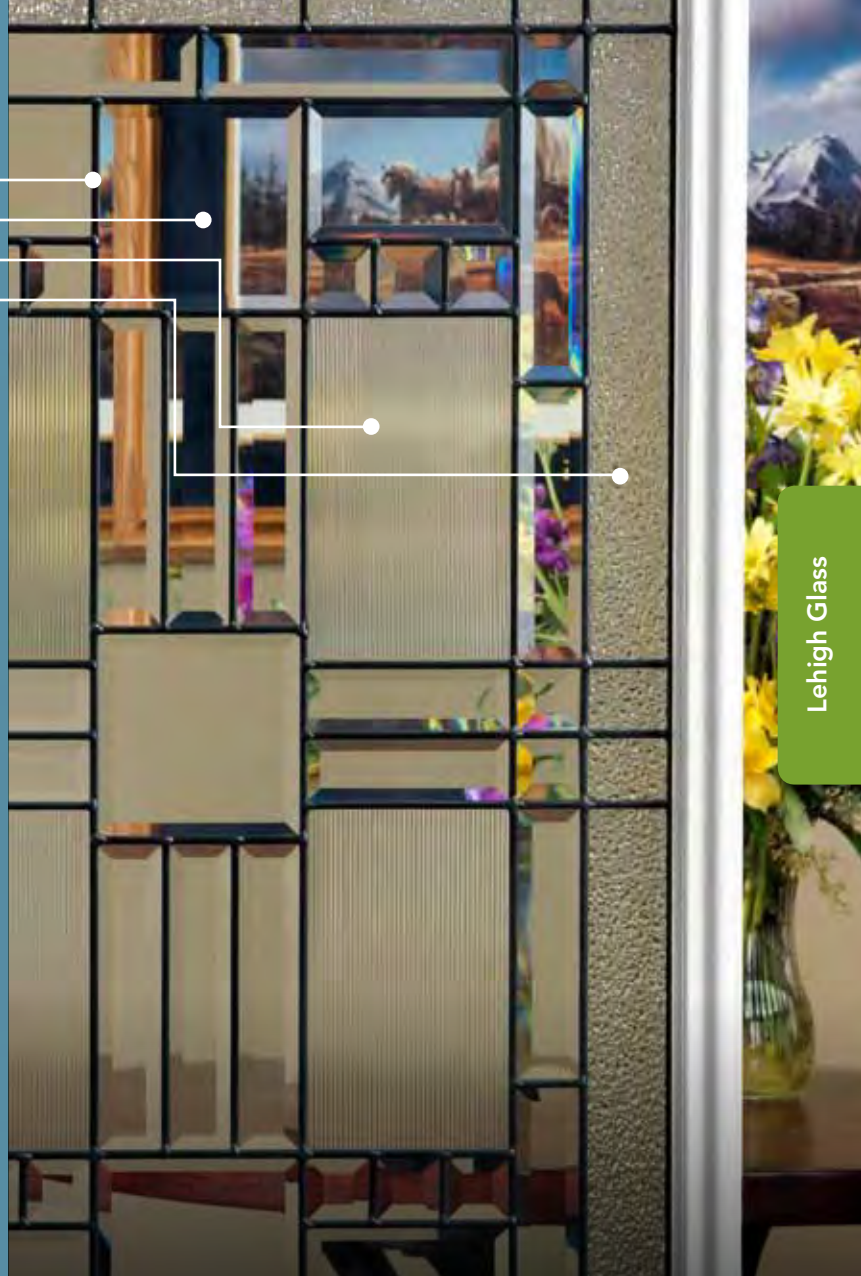
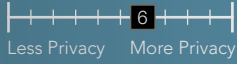

Lehigh Glass



All Entry Systems using Lehigh Glass are ENERGY STAR Qualified.



130LEH  
●●◆  
pg. 49

230LEH  
○□◆  
pg. 21

130LEH  
●●◆  
pg. 49



160LEH  
☞  
pg. 53

420LEH-DS ◆  
☞  
pg. 12

160LEH  
☞  
pg. 53



- Signet and Heritage Fiberglass
- ☞ Signet Fir Series Fiberglass
- Heritage Fiberglass
- 20-gauge Woodgrain Textured Steel

- 22-gauge Woodgrain Textured Steel
- ◆ Smooth Steel
- ◆ For additional door panel styles see pg. 6 (for Signet) pg. 8 (Heritage) or pg. 10 (Legacy)

# series Emerald

Emerald features brass or zinc coming in a simple yet pleasing design that features beauty and privacy.



460EME, 160EME

## Emerald Styles

612/613EME pg. 80



160EME ●◆ pg. 53  
460EME ●◆ pg. 39  
160EME ●◆ pg. 53



350EME ○◆ pg. 42



160EME ●◆ pg. 53  
243EME ♯+○ pg. 28  
160EME ●◆ pg. 53

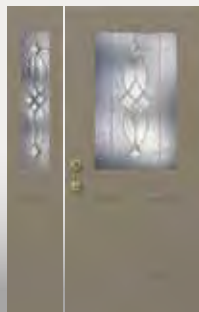

130EME ●◆ pg. 49  
430EME ⇄ ●◆ pg. 17

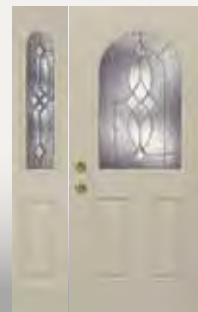

139EME ◆◆ pg. 46  
439EME ⇄ ○◆ pg. 25



230EME ○□◆ pg. 21

- Caming
- Clear Water
- Gluechip
- Clear Beveled

**Caming Finish Available**

- Brass
- Zinc

Specify caming finish using the following codes:  
 Brass - EME, Zinc - EMZ

**Privacy Rating**

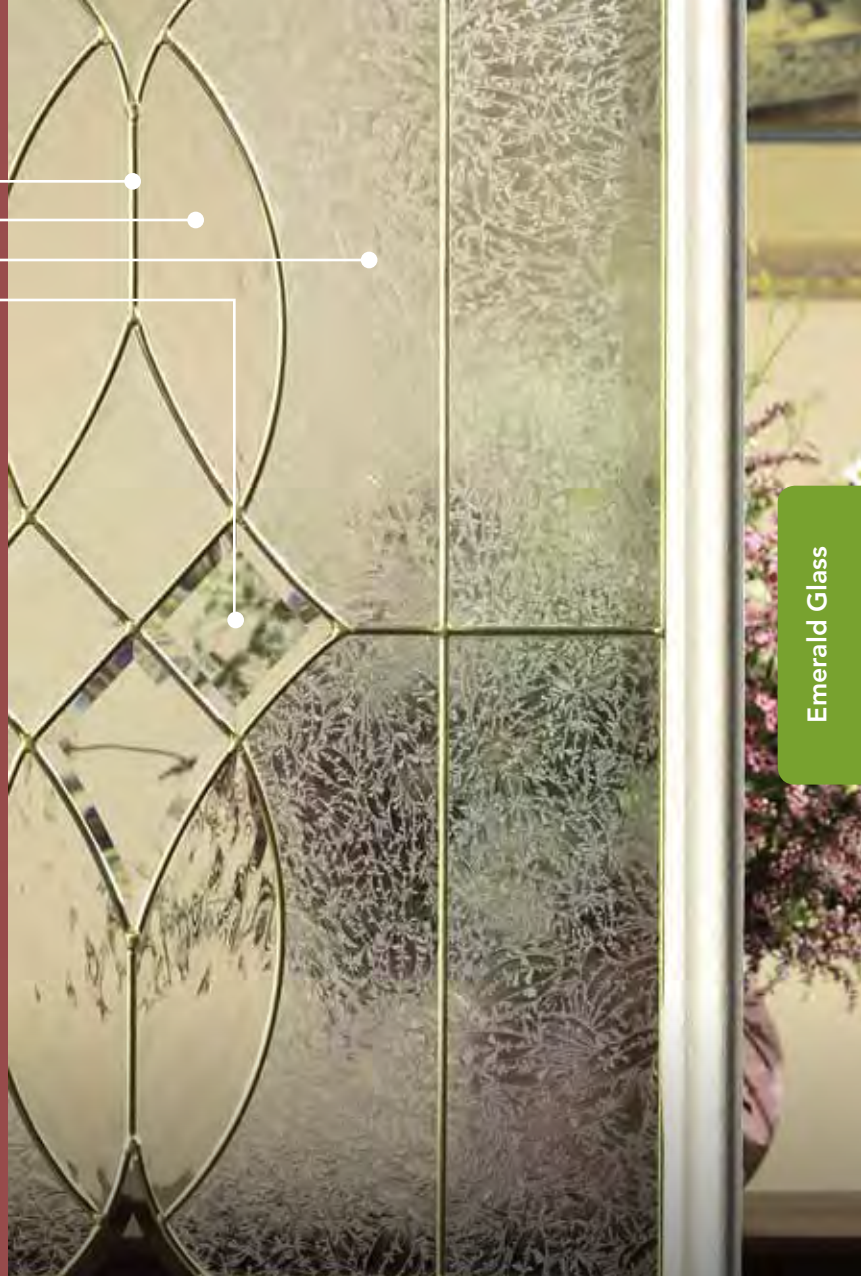
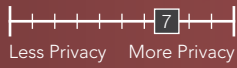

All Entry Systems using Emerald Glass are ENERGY STAR Qualified.

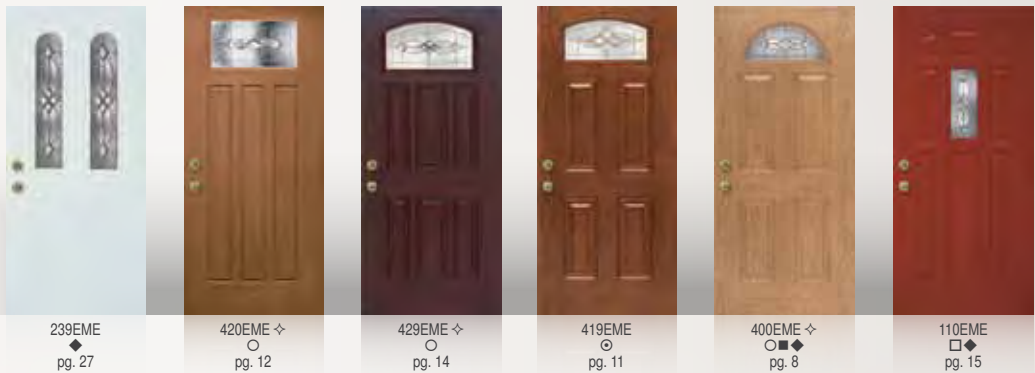

- Signet and Heritage Fiberglass
- Heritage Fiberglass
- ⊙ Signet Fiberglass
- 20-gauge Woodgrain Textured Steel
- ⊛ Signet Cherry Series Fiberglass
- 22-gauge Woodgrain Textured Steel
- + Signet Oak Series Fiberglass
- ◆ Smooth Steel

◊ For additional door panel styles see pg. 6 (for Signet) pg. 8 (Heritage) or pg. 10 (Legacy)

# series Beveled

Beveled is accented with the rich beauty of brass coming and gathers and displays sunlight in an exciting prism effect to brighten your entry.



460BEV, 160BEV, 512/513BEV

## Beveled Styles

612/613BEV pg. 80			512/513BEV pg. 78			712/713BEV** pg. 77			516BEV pg. 82		
160BEV ◆◆◆ pg. 53	460BEV ◆◆◆ pg. 39	160BEV ◆◆◆ pg. 53	130BEV ◆◆◆ pg. 49	430BEV ⇄ ◆◆◆ pg. 17	130BEV ◆◆◆ pg. 49	130BEV ◆◆◆ pg. 49	439BEV ⇄ ○◆◆ pg. 25	130BEV ◆◆◆ pg. 49	230BEV ○□◆ pg. 21		

Brass Caming

Clear Beveled

Caming Finish Available

Brass

Privacy Rating

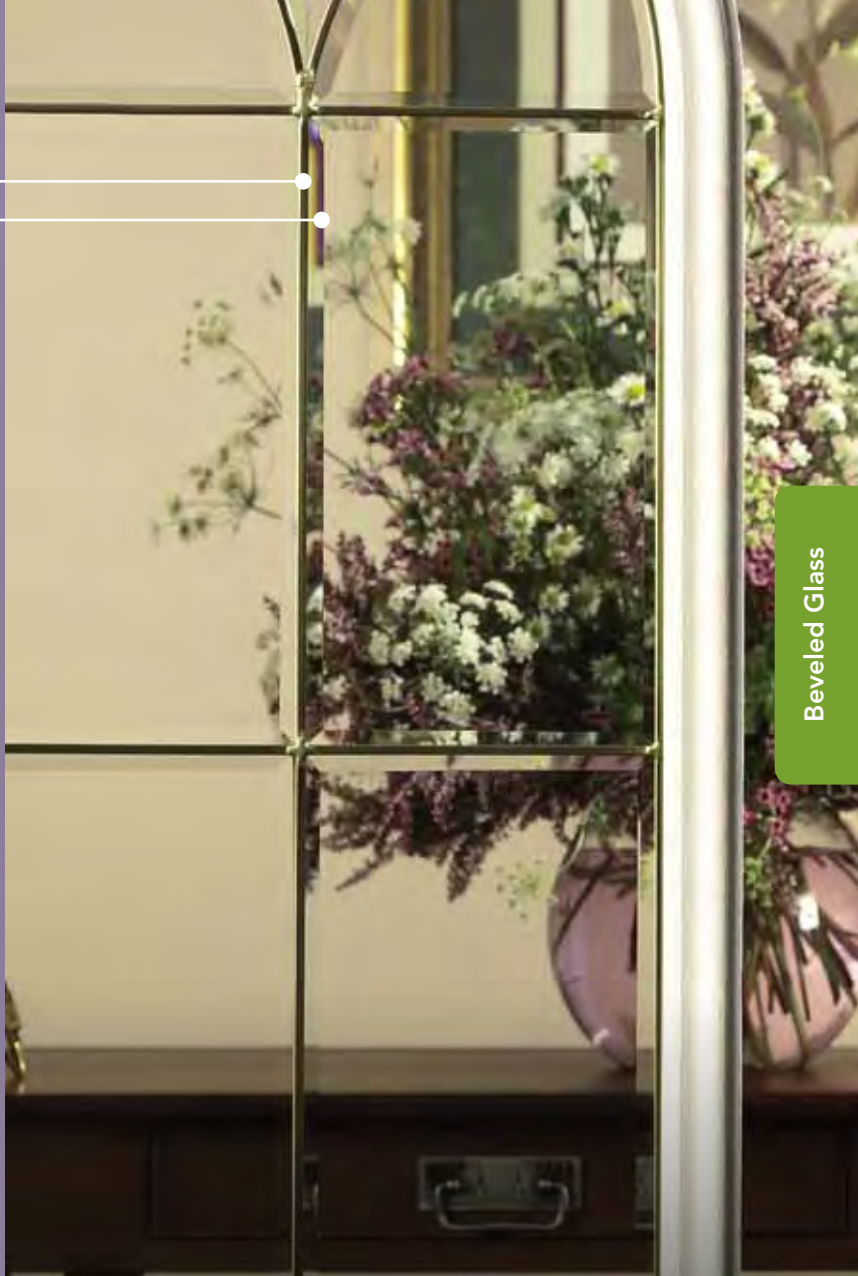
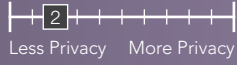

All Entry Systems using Beveled Glass are ENERGY STAR Qualified.



429BEV ◊  
○  
pg. 14

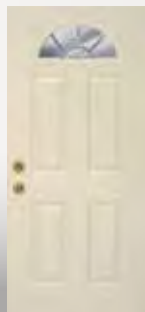

400BEV ◊  
○◆◆  
pg. 8

- Signet and Heritage Fiberglass
- Heritage Fiberglass
- 20-gauge Woodgrain Textured Steel
- 22-gauge Woodgrain Textured Steel

- ◆ Smooth Steel
- ★★ Requires an additional 4-week lead time
- ◊ For additional door panel styles see pg. 6 (for Signet) pg. 8 (Heritage) or pg. 10 (Legacy)



# Diamond series

Diamond combines the rich beauty of bevels with the feathery frost-like texture of gluechip glass for privacy and elegance.



430DIA, 130DIA

## Diamond Styles

612/613DIA pg. 80



160DIA  
●◆  
pg. 54

460DIA  
●◆  
pg. 39

160DIA  
●◆  
pg. 54



350DIA  
○◆  
pg. 42

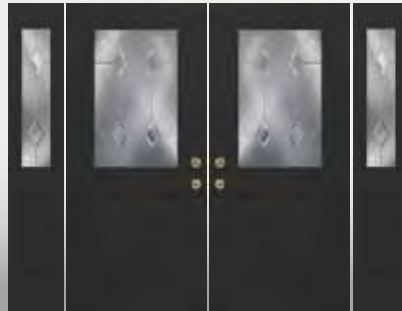

130DIA  
●◆  
pg. 49

430DIA ◆  
●◆  
pg. 17

430DIA ◆  
●◆  
pg. 17

130DIA  
●◆  
pg. 49



230DIA  
○□◆  
pg. 21

Brass Caming

Clear Beveled

Gluechip

Caming Finish Available

Brass

Privacy Rating

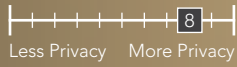

Diamond Glass



All Entry Systems using Diamond Glass are ENERGY STAR Qualified.



400DIA ✧  
○ ◆  
pg. 8



110DIA □ ◆  
pg. 15

- Signet and Heritage Fiberglass
- Heritage Fiberglass
- 20-gauge Woodgrain Textured Steel
- 22-gauge Woodgrain Textured Steel

- ◆ Smooth Steel
- ✧ For additional door panel styles see pg. 6 (for Signet) pg. 8 (Heritage) or pg. 10 (Legacy)

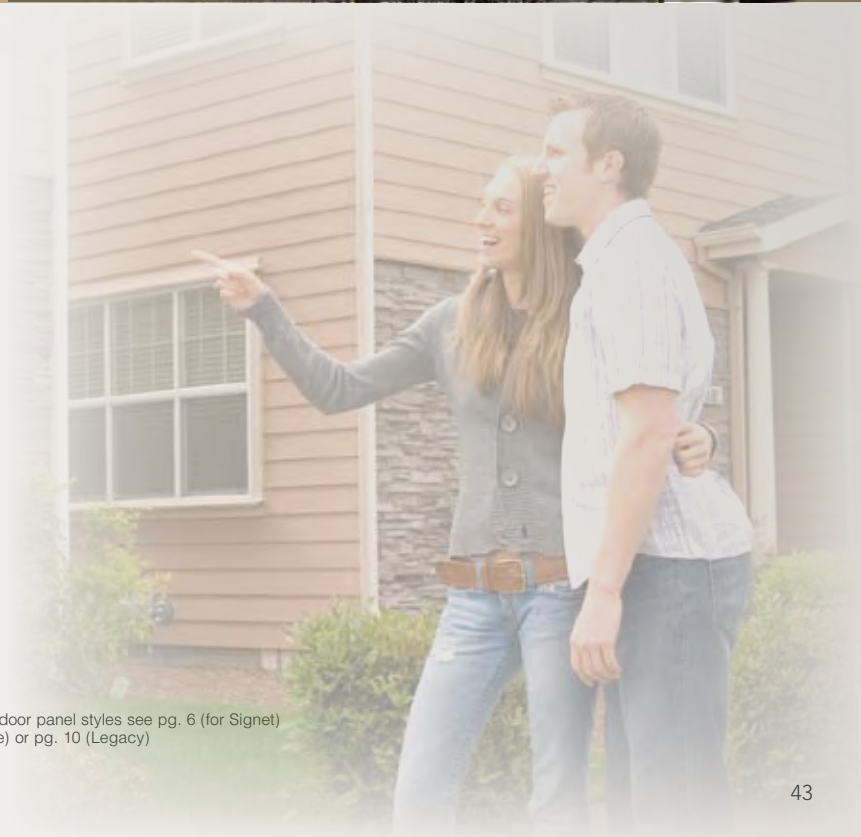

# Tuscany series

Tuscany features a unique lamination that holds shattered glass together maintaining security beautifully.



440TUS



### High Performance Benefits

Remarkable beauty and security at a great price. 99% UV blockage prevents fading of carpets and furniture.



### Forced Entry Deterrent

All glass can be shattered after continuous impact, but these laminated decorative designs are break-through resistant. Deters burglaries and storm damage.

## Tuscany Styles

Tuscany glass is designed to deter burglaries and storm damage. Unfortunately, entry systems with Tuscany glass are not ENERGY STAR qualified.

612/613TUS pg. 80



160TUS  
●◆◆  
pg. 54

350TUS  
○◆◆  
pg. 42

160TUS  
○◆◆  
pg. 54



140TUS  
●◆◆  
pg. 52

440TUS ◆  
●◆◆  
pg. 31

140TUS  
●◆◆  
pg. 52



240TUS  
■◆  
pg. 34



130TUS  
●◆◆  
pg. 49

430TUS ◆  
●◆◆  
pg. 17

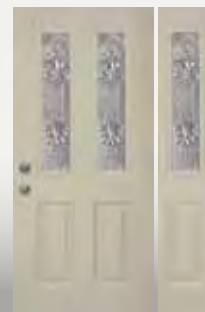

230TUS  
○□◆  
pg. 21

130TUS  
●◆◆  
pg. 49

- Signet and Heritage Fiberglass
- Heritage Fiberglass
- 20-gauge Woodgrain Textured Steel
- 22-gauge Woodgrain Textured Steel

- ◆ Smooth Steel
- ◆ For additional door panel styles see pg. 6 (for Signet) pg. 8 (Heritage) or pg. 10 (Legacy)

Privacy Rating



Tuscany Glass





series

# Twilight



All Twilight Glass includes **Comfortech DLA High Performance Low-E Argon Glass.**

Twilight is a beautiful decorative silk-screen art of our own design. It's unique frosted glass adds to the warmth and privacy of your home.



430TWI

## Twilight Styles



160TWI  
○◆◆  
pg. 54

350TWI  
○◆◆  
pg. 42

160TWI  
○◆◆  
pg. 54



130TWI  
●◆◆  
pg. 49

430TWI ⇄  
●◆◆  
pg. 17

430TWI ⇄  
●◆◆  
pg. 17

130TWI  
●◆◆  
pg. 49

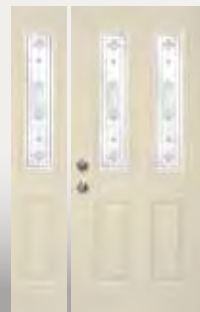

130TWI  
●◆◆  
pg. 49

230TWI  
○□◆  
pg. 22

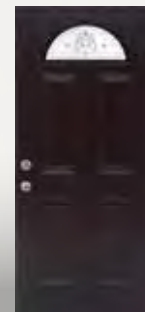

400TWI ⇄  
○◆◆  
pg. 9

Clear

Frosted

Although in the photos below the silk-screen pattern appears gray, it is clear glass as shown here.

### Privacy Rating

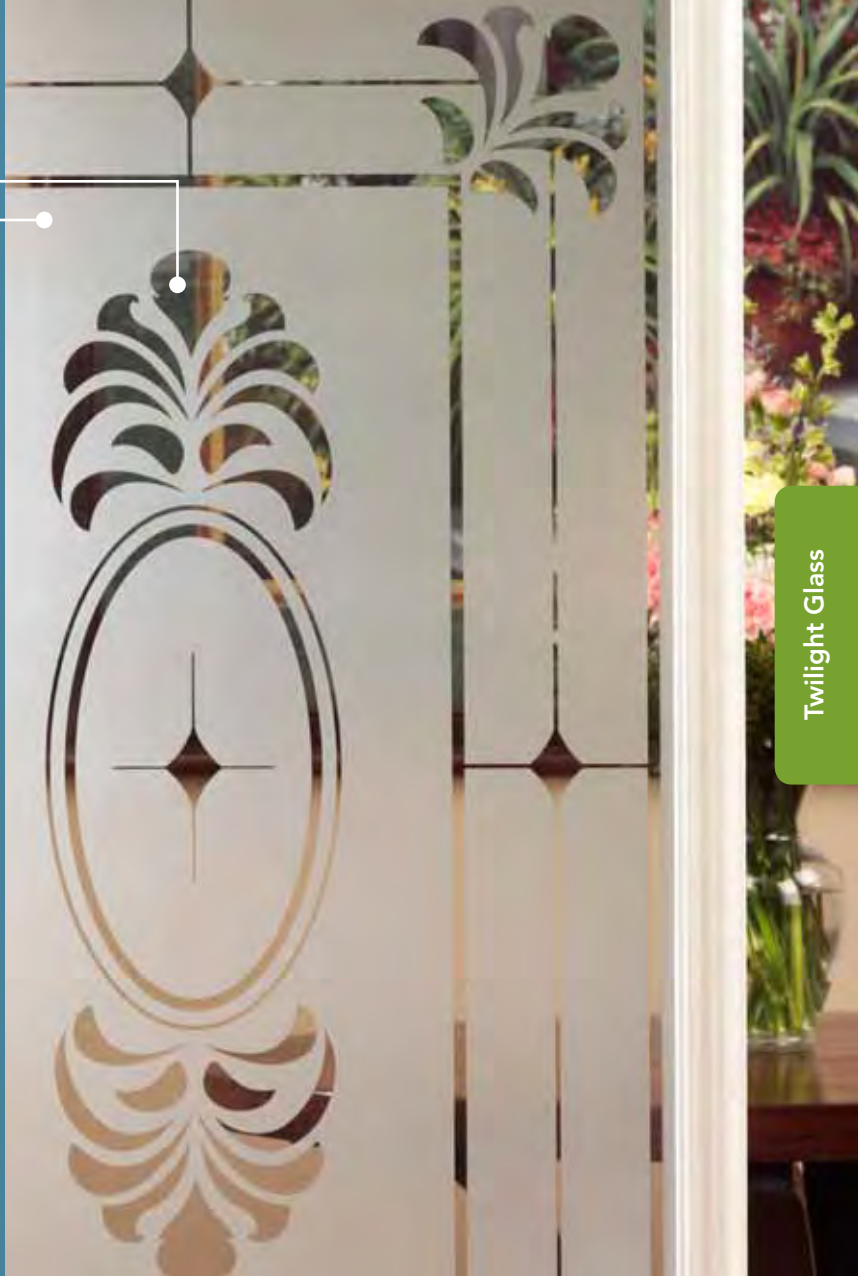
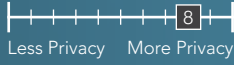

Twilight Glass



All Entry Systems using Twilight Glass are ENERGY STAR Qualified.



160TWI  
○■◆  
pg. 54

110TWI  
□◆  
pg. 15

160TWI  
○■◆  
pg. 54

- Signet and Heritage Fiberglass
- Heritage Fiberglass
- 20-gauge Woodgrain Textured Steel
- 22-gauge Woodgrain Textured Steel

- ◆ Smooth Steel
- ✦ For additional door panel styles see pg. 6 (for Signet) pg. 8 (Heritage) or pg. 10 (Legacy)





Art Glass

# Inspirations™



All Inspirations Art Glass includes our **ComforTech Glazing System.**

Inspirations Art Glass allows you to do just what the name suggests, let your doors and windows reflect the inspiration of your imagination with your choice of design and color.



770VIN, 150VIN (Timberland)



**Designs:**

The process begins with conceptual design. Our eight beautiful Inspirations Art Glass styles originated from the imagination of our in-house designers.

**Resin Bead:**

The design pattern is created on our computer software, and sent to a CNC machine which applies a resin bead to the surface of the glass in one of our four stylish colors.

**Color Fill:**

The color fill truly brings the glass to life. Five distinct color palettes are offered empowering you to perfectly reflect the personality of you and your home. Our craftsmen hand-apply this color fill to your glass.

**Our Guarantee:**

The resin bead and color fill are backed by our Lifetime Limited Warranty, and will not fade, blister or peel away from the glass.



Ask to see our Inspirations Art Glass brochure for available styles and color palettes, or use ProVia Studio to create custom color palettes & design your dream door.



Inspirations Art Glass

Collection

# Privacy



All Privacy Glass includes our **ComforTech Glazing System.**

Privacy glass allows light to filter in, while keeping a high level of privacy with Chinchilla, Taffeta, Waterfall, Gluechip and Obscure Pebble glass.



All entry systems with Privacy Glass can be ENERGY STAR qualified depending on the glazing system you choose. This chart indicates which glazing system is required for ENERGY STAR qualification, as well as availability.

Door Styles	Glazing Systems			
Half-lite or Larger 460, 460, 449, 440, 437, 430, 430, 439, 240, 239, 230	TLK	TLA	DLA	DC
Smaller than Half-lite 429, 420, 419, 400, 400, 243, 110	DC			

ENERGY STAR Qualified  
Refer to pg. 13 for Glazing Systems information

Since Low-E glass has a slight color tint, it is recommended that sidelites be ordered with the same glazing system as the door.



## Privacy Options

Chinchilla



Privacy Rating



Taffeta



Privacy Rating



Waterfall



Privacy Rating



Gluechip



Privacy Rating

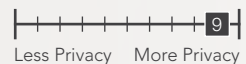

Obscure Pebble



Privacy Rating



# Privacy Styles



460GLC  
●■◆  
pg. 40

460GLC-EG  
○■◆  
pg. 41

449GLC †  
⌘  
pg. 37

440GLC †  
●■◆  
pg. 32

437GLC †  
◆  
pg. 24

430GLC †  
●■◆  
pg. 19

430GLC-EG †  
○■◆  
pg. 19

439GLC †  
○■◆  
pg. 26



243GLC  
⌘+○  
pg. 30

240GLC  
■◆  
pg. 35

239GLC  
◆  
pg. 27

230GLC  
○□◆  
pg. 23

230GLC-EG  
○□◆  
pg. 23

429GLC †  
○  
pg. 14

420GLC-DS †  
⌘  
pg. 13

419GLC  
○  
pg. 11

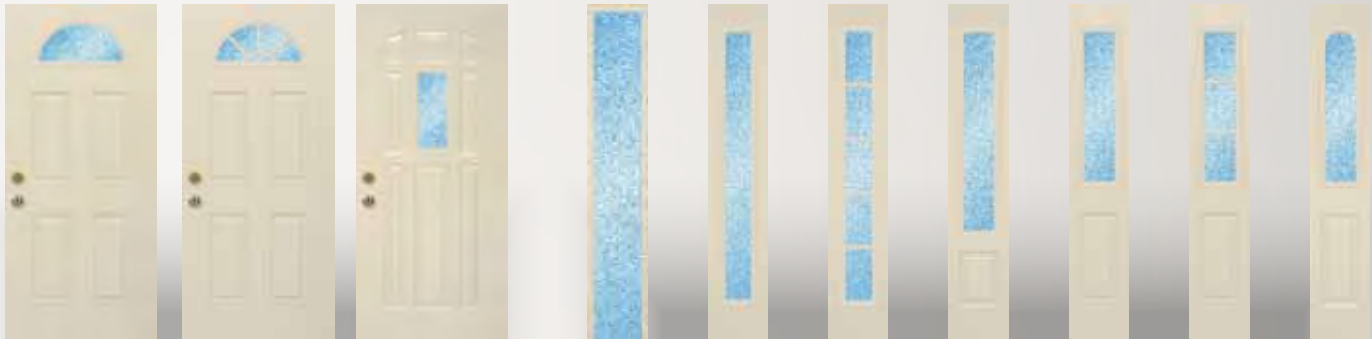

400GLC †  
○■◆  
pg. 10

400GLC-EG †  
○■◆  
pg. 10

110GLC  
□◆  
pg. 15

770GLC§  
●■◆  
pg. 61

160GLC  
●■◆  
pg. 54

160GLC-EG  
○■◆  
pg. 54

140GLC  
●■◆  
pg. 52

130GLC  
●■◆  
pg. 50

130GLC-EG  
○■◆  
pg. 50

139GLC  
■◆  
pg. 51

- Signet and Heritage Fiberglass
- Signet Fiberglass
- ⌘ Signet Cherry Series Fiberglass
- + Signet Oak Series Fiberglass
- ⌘ Signet Fir Series Fiberglass
- Heritage Fiberglass
- 20-gauge Woodgrain Textured Steel
- 22-gauge Woodgrain Textured Steel
- ◆ Smooth Steel
- § Also available in 10" width. See Price List for design pattern
- † For additional door panel styles see pg. 6 (for Signet) pg. 8 (Heritage) or pg. 10 (Legacy)

# Internal Blinds

Internal Blinds are constructed with sturdy white aluminum blinds enclosed in tempered safety glass for energy efficiency. Easy to clean; no more dusting of blinds. Suitable for entry doors, sidelites and patio doors and carry a 10-Year Warranty.



460BLR-IGP



All entry systems with Internal Blinds can be ENERGY STAR qualified depending on the glazing system you choose. This chart indicates which glazing system is required for ENERGY STAR qualification, as well as availability.

Door Styles	Glazing Systems	
Internal Blinds with: Colonial Grids Prairie Grids Cottage Grids	DLA	DC
Internal Blinds Without Grids	DLA	DC

**ENERGY STAR Qualified**  
Refer to pg. 13 for Glazing Systems information

Since Low-E glass has a slight color tint, it is recommended that sidelites are ordered with the same glazing system as the door.

Additional Light Control - BLR styles can also be raised and lowered completely.

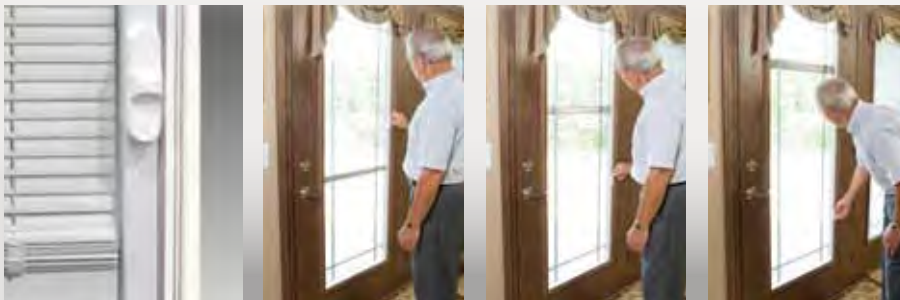

Internal Blinds also available with optional Low-E.

Note: 160BLD-IGT, 160BLD-IGP, 160BLD-IGC and 160BLD cannot be raised and lowered.

# Blinds with Internal Grids Grids available in all colors listed on page 54.

## Colonial (Traditional Grids)



## Prairie Grids



## Cottage Grids



## Blinds (without grids)



- Heritage Fiberglass
- 20-gauge Woodgrain Textured Steel
- 22-gauge Woodgrain Textured Steel
- ◆ Smooth Steel
- ◇ For additional door panel styles see pg. 6 (for Signet) pg. 8 (Heritage) or pg. 10 (Legacy)

# Internal Grids



All Internal Grids include our **ComforTech Glazing System.**



Internal Grids add style to your clear glass. Choose from pencil or contoured grids available in a wide variety of finishes.



All entry systems with Internal Grids can be ENERGY STAR qualified depending on the glazing system you choose. This chart indicates which glazing system is required for ENERGY STAR qualification, as well as availability.

Door Styles	Glazing Systems		
Half-lite or Larger 460, 449, 440, 437, 430, 240 230	TLA*	DLA	DC
Smaller than Half-lite 429, 420, 419, 400,	DC		

**ENERGY STAR Qualified**  
Refer to pg. 13 for Glazing Systems information

Since Low-E glass has a slight color tint, it is recommended that sidelites and transoms are ordered with the same glazing system as the door.

\* Not available on Signet doors.



460DLA-IGT

## Grid Options



Painted Contoured



Stained Contoured



Brass Pencil  
Not available in Prairie Grids



Satin Nickel Pencil  
Not available in Prairie Grids



Bronze Pencil  
Not available in Prairie Grids

## Contoured Grid Colors and Stains

Snow Mist	Café Cream	Sandpiper Beige	Sandstone	Clay	Forest Green	Mountain Berry
Rustic Bronze	Tudor Brown	Coal Black ††	Light Oak †*	Oak †	Cherry †*	

## Two-Tone Contoured Grids

Snow Mist	Snow Mist	Snow Mist	Snow Mist	Snow Mist	Snow Mist
Café Cream	Sandpiper Beige	Sandstone	Forest Green	Mountain Berry	Light Oak †*
Snow Mist	Snow Mist	Sandpiper Beige	Sandpiper Beige	Sandpiper Beige	
Oak †	Cherry †*	Light Oak †*	Oak †	Cherry †*	

† Not available in 400DC-IG

†† Not available in 400DC-IG unless Special Ordered

\* Light Oak stained grids also match Signet Honey Wheat stain. Cherry stained grids also match Signet American Cherry and Truffle stains.



532DC-IGS pg. 82



512/513DC-IGS pg. 74



612/613DC-IGS pg. 81



712/713DC-IGS\*\* pg. 78



516DC-IGS pg. 82



612/613DC-IGT pg. 81



616DC-IGT pg. 83



616DC-IGP pg. 83

### Colonial (Traditional Grids)



460DC-IGT ●●◆ pg. 41    449DC-IGT † § pg. 37    440DC-IGT † ●●◆ pg. 33    437DC-IGT † ◆ pg. 24    430DC-IGT † ●●◆ pg. 20    240DC-IGT ■◆ pg. 36    230DC-IGT ○□◆ pg. 23    420DC-IGT-DS † § pg. 13    400DC-IG † ○◆ pg. 10    770DC-IGT § ●●◆ pg. 61    160DC-IGT ●●◆ pg. 55    140DC-IGT ●●◆ pg. 53    130DC-IGT ●●◆ pg. 50

Internal Grids

### Prairie Grids Not available in Pencil Grids.



460DC-IGP ●●◆ pg. 41    449DC-IGP † § pg. 37    440DC-IGP † ●●◆ pg. 33    437DC-IGP † ◆ pg. 24    430DC-IGP † ●●◆ pg. 20    240DC-IGP ■◆ pg. 36    230DC-IGP ○□◆ pg. 23    429DC-IGP † ○ pg. 14    420DC-IGP-DS † § pg. 13    770DC-IGP § ●●◆ pg. 61    160DC-IGP ●●◆ pg. 55    140DC-IGP ●●◆ pg. 53    130DC-IGP ●●◆ pg. 50

### Cottage Grids



460DC-IGC ●●◆ pg. 41    449DC-IGC † § pg. 37    440DC-IGC † ●●◆ pg. 33    437DC-IGC † ◆ pg. 24    430DC-IGC † ●●◆ pg. 20    240DC-IGC ■◆ pg. 36    230DC-IGC ○□◆ pg. 23    429DC-IGC † ○ pg. 14



420DC-IGC-DS † § pg. 13    419DC-IGC ○ pg. 11    770DC-IGC § ●●◆ pg. 61    160DC-IGC ●●◆ pg. 55    140DC-IGC ●●◆ pg. 53    130DC-IGC ●●◆ pg. 50

- Signet and Heritage Fiberglass
- Signet Fiberglass
- § Signet Cherry Series Fiberglass
- † Signet Oak Series Fiberglass
- § Signet Fir Series Fiberglass
- Heritage Fiberglass
- 20-gauge Woodgrain Textured Steel
- 22-gauge Woodgrain Textured Steel
- ◆ Smooth Steel
- † For additional door panel styles see pg. 6 (for Signet) pg. 8 (Heritage) or pg. 10 (Legacy)
- § Also available in 10" width. See Price List for design pattern
- \*\* Requires an additional 4-week lead time

# External Grids



All External Grids include our **ComforTech Glazing System.**

External Grids are ideal for your side, back and garage service door. Choose the style to suit your taste.



430DC-EG



All entry systems with External Grids and Signet Simulated Divided Lites can be ENERGY STAR qualified depending on the glazing system you choose. This chart indicates which glazing system is required for ENERGY STAR qualification, as well as availability.

Door Styles	Glazing Systems			
Half-lite or Larger 460, 440, 439, 430, 230	TLK	TLA	DLA	DC
Smaller than Half-lite 420, 410, 400	DC			

ENERGY STAR Qualified  
Refer to pg. 13 for Glazing Systems information

Since Low-E glass has a slight color tint, it is recommended that sidelites and transoms are ordered with the same glazing system as the door.



## External Grid Styles



460DC-EG  
○◆◆  
pg. 41



439DC-EG ◆  
○◆◆  
pg. 26



430DC-EG ◆  
○◆◆  
pg. 19



230DC-EG  
○□◆  
pg. 23

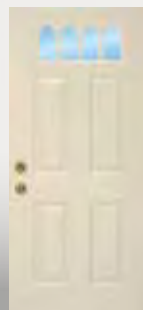

410DC-EG\*  
○◆◆  
pg. 46



400DC-EG ◆  
○◆◆  
pg. 10



160DC-EG  
○◆◆  
pg. 55



130DC-EG  
○◆◆  
pg. 50

- Heritage Fiberglass
- 20-gauge Woodgrain Textured Steel
- ◆ Smooth Steel
- ◆ For additional door panel styles see pg. 8 (Heritage) or pg. 10 (Legacy)

## Simulated Divided Lites for Signet Fiberglass

Simulated Divided Lites (SDL) on our Signet Fiberglass entry doors are reminiscent of old world craftsmanship when separate pieces of glass were mull together with wooden grids. We deliver that same stunning appearance through our high-tech stained fiberglass 1" wide x 11/32" thick grids combined with the energy efficiency qualities of our ComforTech glass packages.



**Contoured** - Available in Signet Cherry, Mahogany, and Oak Series



**Craftsman** - Available in Signet Fir Series



External Grids / SDL's

## Signet SDL Grid Styles

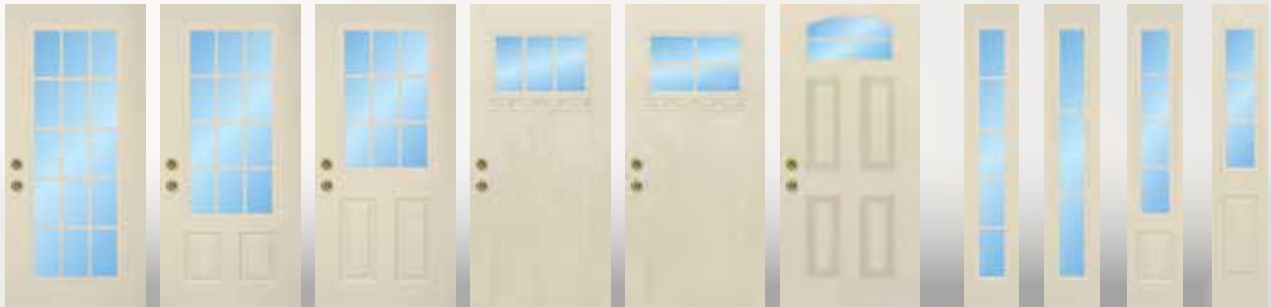

460DC-SDT  
⊙  
pg. 41

440DC-SDT ✦  
⊙  
pg. 33

430DC-SDT ✦  
⊙  
pg. 19

420DC-SDT  
⊙  
pg. 13

420DC-SDC  
⊙  
pg. 13

419DC-SDC  
⊙  
pg. 11

160DC-SDT  
⊙  
pg. 55

160DC-SDC  
⊙  
pg. 55

140DC-SDT  
⊙  
pg. 53

130DC-SDT  
⊙  
pg. 50

**Note** - All Signet doors and sidelites with SDL's are available with privacy glass.

- ⊙ Signet Fiberglass
- ⊙ Signet Fir Series Fiberglass
- ✦ For additional door panel styles see pg. 6

# Clear Glass

Clear Glass is appropriate on every entry of your home and can still be energy efficient.



All Clear Glass includes our **ComforTech Glazing System.**



All entry systems with Clear Glass can be ENERGY STAR qualified depending on the glazing system you choose. This chart indicates which glazing system is required for ENERGY STAR qualification, as well as availability.

Door Styles	Glazing Systems			
Half-lite or Larger 460, 449, 440, 439, 437, 430, 430-F, 350, 240, 239, 230, 150	TLK	TLA	DLA	DC
Smaller than Half-lite 429, 420, 419, 400, 306, 243, 206 131, 110, 101, 100	DC			

ENERGY STAR Qualified  
Refer to pg. 13 for Glazing Systems information

Since Low-E glass has a slight color tint, it is recommended that sidelites are ordered with the same glazing system as the door.





532DC pg. 82



712/713DC\*\* pg. 77



516DC pg. 82



512/513DC pg. 79



612/613DC pg. 81



616DC pg. 83



460DC  
●■◆  
pg. 41



449DC †  
⊕  
pg. 37



440DC †  
●■◆  
pg. 33



439DC †  
○◆  
pg. 26



437DC †  
◆  
pg. 24



430DC †  
●■◆  
pg. 19



430DC-F †  
○◆  
pg. 47



350DC  
○◆  
pg. 43



243DC  
⊕  
pg. 30



240DC  
◆  
pg. 35



239DC  
◆  
pg. 27



230DC  
○◆  
pg. 23



150DC  
◆  
pg. 45



429DC †  
○  
pg. 14

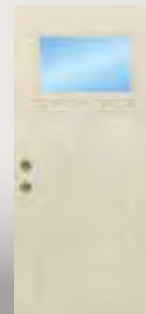

420DC-DS †  
⊕  
pg. 13

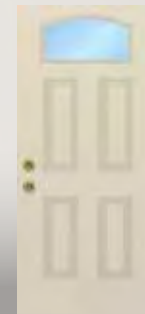

419DC  
○  
pg. 11



400DC †  
○◆  
pg. 10



306DC  
○◆  
pg. 47

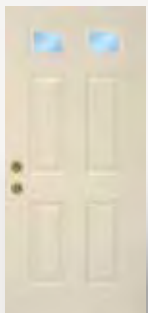

206DC  
○◆  
pg. 46



131DC  
○◆  
pg. 47



110DC  
□  
pg. 16

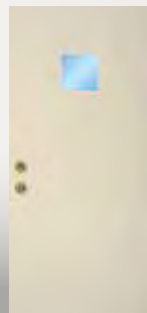

101DC  
○◆  
pg. 47

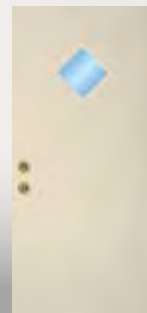

100DC  
○◆  
pg. 47



770DC§  
●■◆  
pg. 61



160DC  
●■◆  
pg. 55



140DC  
●■◆  
pg. 53



130DC  
●■◆  
pg. 50



139DC  
◆  
pg. 51



106DC  
◆  
pg. 55

- Signet and Heritage Fiberglass
- Signet Fiberglass
- ⊕ Signet Cherry Series Fiberglass
- + Signet Oak Series Fiberglass

- ⊕ Signet Fir Series Fiberglass
- Heritage Fiberglass
- 20-gauge Woodgrain Textured Steel
- 22-gauge Woodgrain Textured Steel

- ◆ Smooth Steel
- § Also available in 10" width. See Price List for design pattern
- \*\* Requires an additional 4-week lead time
- † For additional door panel styles see pg. 6 (for Signet) pg. 8 (Heritage) or pg. 10 (Legacy)

Clear Glass

# Doors Without Glass

Doors Without Glass will fill your needs beautifully when privacy is needed.

WELCOME



All Entry Systems Without Glass are ENERGY STAR Qualified.

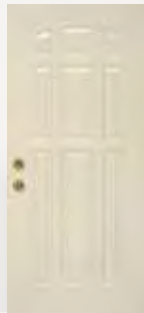

009  
□◆  
pg. 7



008P  
⌘+○  
pg. 7

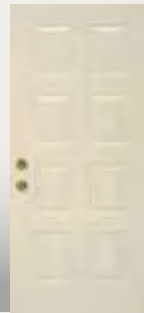

008  
◆  
pg. 7

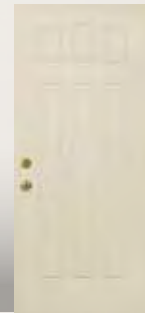

006C  
○  
pg. 6



006  
●■◆  
pg. 6

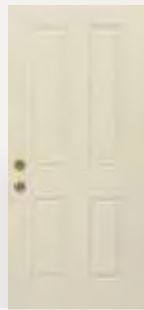

004  
○  
pg. 6



003  
◆◇  
pg. 5

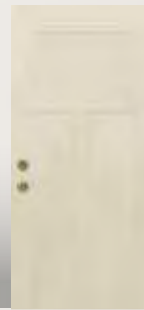

003C  
⌘  
pg. 6



002C-449  
⌘  
pg. 5

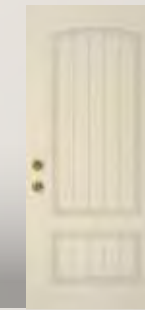

002CP-449  
⌘  
pg. 5

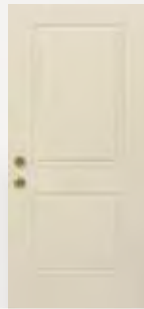

002  
○  
pg. 5

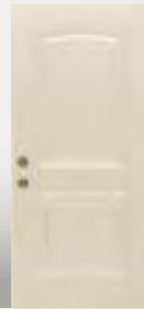

002C-437  
◆  
pg. 5



002CP-437  
◆  
pg. 5

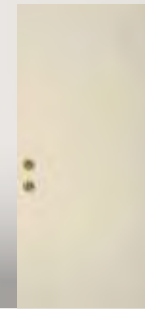

001  
○■◆  
pg. 47

- Signet and Heritage Fiberglass
- ⌘ Signet Cherry Series Fiberglass
- + Signet Oak Series Fiberglass
- ⌘ Signet Fir Series Fiberglass

- Heritage Fiberglass
- 20-gauge Woodgrain Textured Steel
- 22-gauge Woodgrain Textured Steel
- ◆ Smooth Steel
- ◇ For additional door panel styles see pg. 6 (for Signet) pg. 8 (Heritage) or pg. 10 (Legacy)

# Finishes



**WE** do  
the finishing...

If you buy an entry system and finish it yourself, chances are it's the first door you've ever painted or stained. At ProVia, each Signet door is factory finished in a controlled environment with our DuraFuse™ Finishing System ensuring a consistent, beautiful, lasting finish every time.



Stains are hand-applied by professional craftsmen, many of whom have been perfecting their work for years, with thousands of finished entry systems under their belt.



**10-Year\*  
Finish  
Warranty**

*for Signet Fiberglass  
Entry Systems*



**7-Year\*  
Finish  
Warranty**

*for Heritage Fiberglass  
and Legacy Steel  
Entry Systems*



\* Warranty time period may be limited in extreme exposure applications. See warranty for details.

...so **YOU**  
don't have to.

You wouldn't try to paint one of these yourself, so why should it be any different when it comes to painting or staining your entry door?

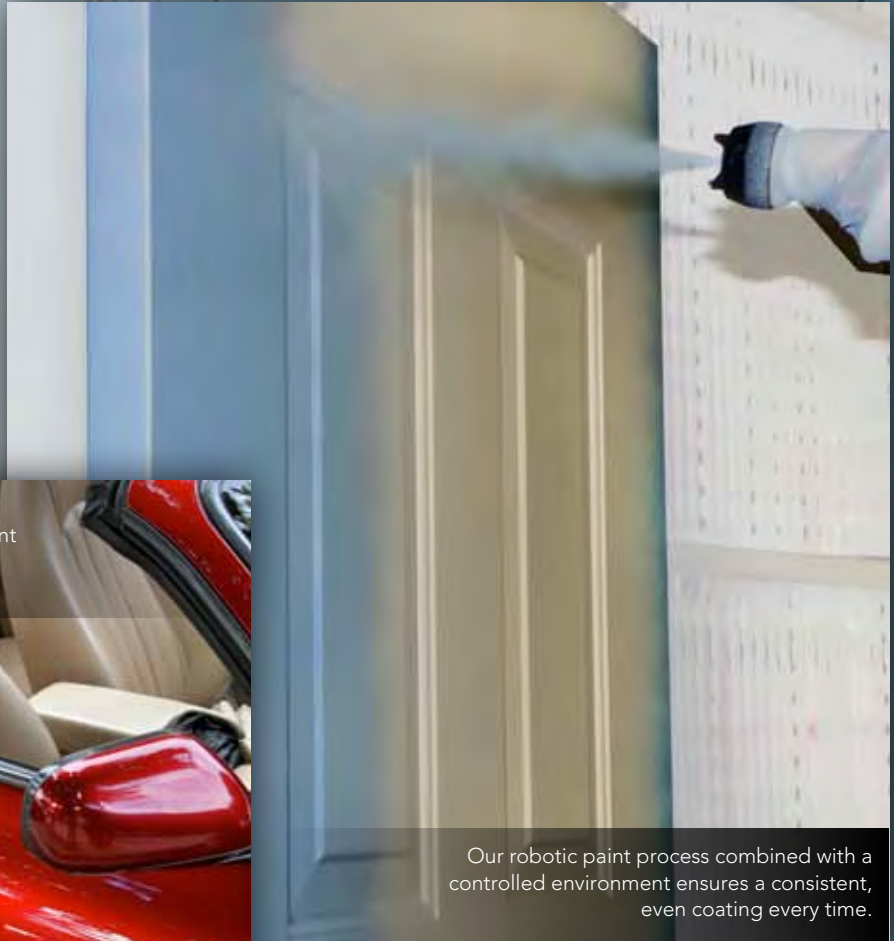

Our robotic paint process combined with a controlled environment ensures a consistent, even coating every time.

Finishes

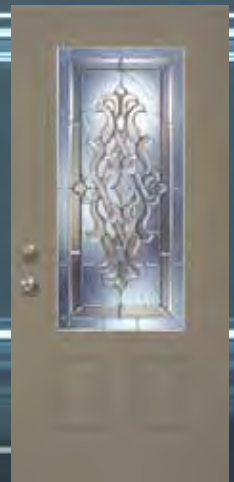
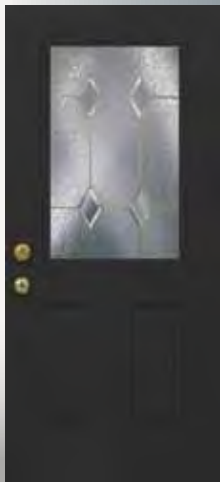

# Signet Fiberglass Finishes

## DuraFuse™ Stain Finishing System

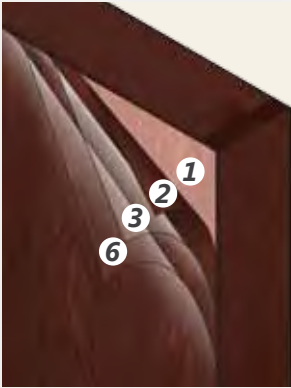

- 1. P<sup>3</sup> Fusion**  
Proprietary Preparation Processes ensuring unprecedented finish durability
- 2. Stain Finish**  
Hand-applied finish formulated exclusively for Signet fiberglass
- 3. UV Resistant Clear Coat**  
A layer of 2-part urethane, catalyst hardened clear coat with UV inhibitors is applied
- 4. Oven-Cured**  
Clear coat is oven-cured for lasting durability
- 5. Hand-Sanded**  
The door is sanded, preparing the surface for the second layer of clear coat
- 6. UV Resistant Clear Coat**  
A second layer of 2-part urethane, catalyst hardened clear coat with UV inhibitors is applied
- 7. Oven-Cured**  
The door is oven-cured a second time, creating a long-lasting, durable finish

## Signet Cherry and Mahogany Stains

To select stain color, refer to our color selector for accurate color representation.

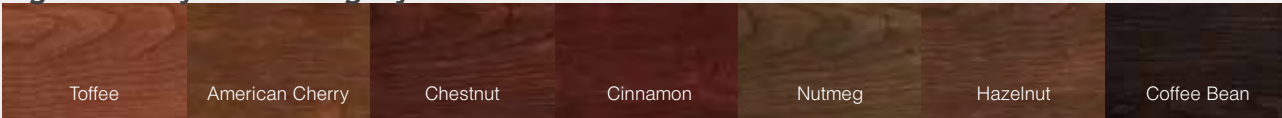

## Signet Oak and Fir Stains

To select stain color, refer to our color selector for accurate color representation.

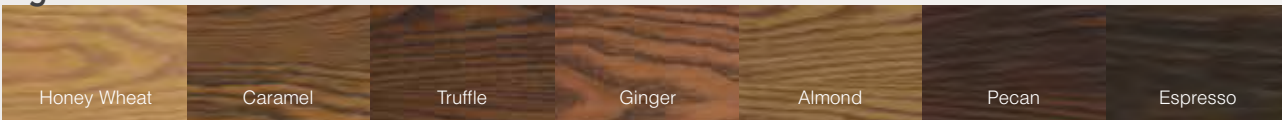

## DuraFuse™ Paint Finishing System

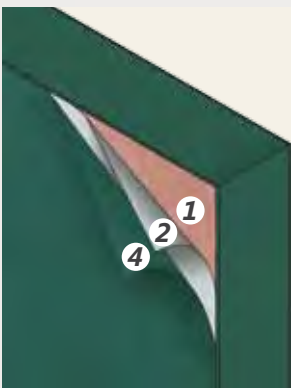

- 1. P<sup>3</sup> Fusion**  
Proprietary Preparation Processes ensuring unprecedented finish durability
- 2. Base Coat (Prime Paint)**  
A 2-part urethane, catalyst hardened base coat is applied by a robotic reciprocating paint system
- 3. Oven-Cured**  
Base coat is oven-cured for lasting durability
- 4. Finish Coat**  
The door is then coated with a 2-part urethane, catalyst hardened finish coat
- 5. Oven-Cured**  
The door is oven-cured a second time, creating a long-lasting, durable finish

## Signet Cherry, Mahogany, Oak and Fir Paint Colors

To select paint color, refer to our color selector for accurate color representation.

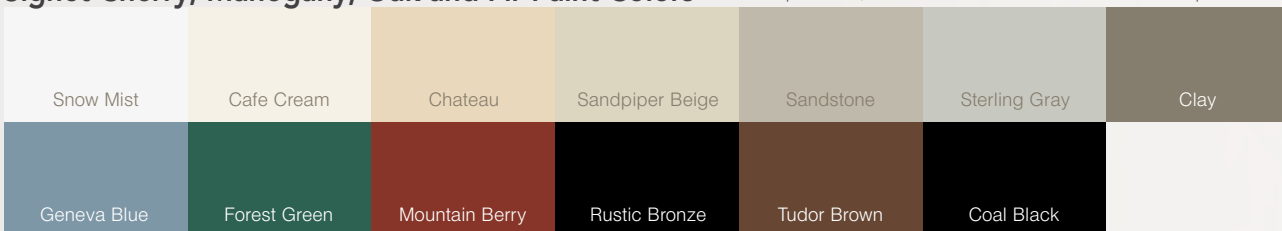

### Limited Colors

Available on entry doors and storm doors. Matching cladding and caulking not available.

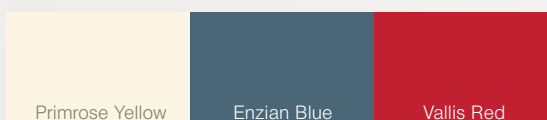

# Heritage Fiberglass & Legacy Steel Finishes

## 5-Step Stain Finishing System

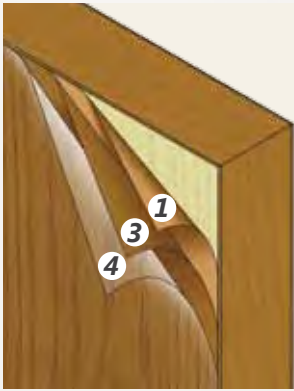

- 1. Base Coat (Prime Paint)**  
A 2-part urethane, catalyst hardened base coat is applied by a robotic reciprocating paint system
- 2. Oven-Cured**  
The base coat is oven-cured for lasting durability
- 3. Stain Finish**  
A coating of hand-applied stain is added for enhanced beauty
- 4. UV Resistant Clear Coat**  
A layer of 2-part urethane, catalyst hardened clear coat with UV inhibitors is applied
- 5. Oven-Cured**  
The door is oven-cured a second time, creating a long-lasting, durable finish

## Heritage Fiberglass & Legacy Textured Steel Doors

To select stain color, refer to our color selector for accurate color representation.

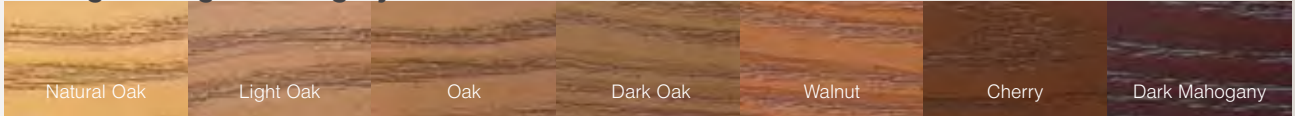

Photos below are intended to show the variations in woodgrain texture and pattern.



Heritage Fiberglass

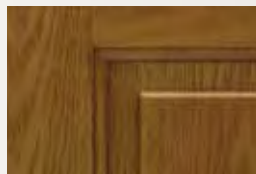

Legacy 20-gauge  
Woodgrain Textured Steel

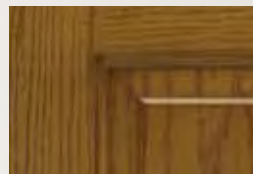

Legacy 22-gauge  
Woodgrain Textured Steel

## 5-Step Paint Finishing System



- 1. A40 Hot-dipped Galvannealed**  
300% more coating thickness than 40Z Full Electrolytic Zinc Coated steel, resisting rust inside and out
- 2. Base Coat (Prime Paint)**  
A 2-part urethane, catalyst hardened base coat is applied by a robotic reciprocating paint system
- 3. Oven-Cured**  
Base coat is oven-cured for lasting durability
- 4. Finish Coat**  
The door is then coated with a 2-part urethane, catalyst hardened finish coat using our state-of-the-art electrostatic application
- 5. Oven-Cured**  
The door is oven-cured a second time, creating a long-lasting, durable finish

## Heritage Fiberglass & Legacy Steel Doors

To select paint color, refer to our color selector for accurate color representation.

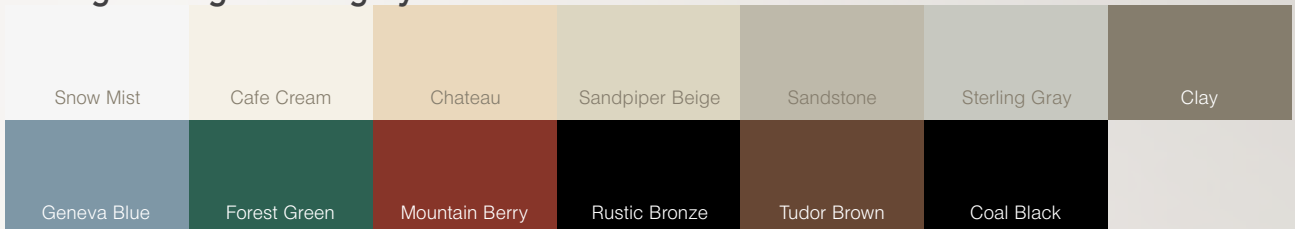

### Limited Colors

Available on entry doors and storm doors.  
Matching cladding and caulking not available.

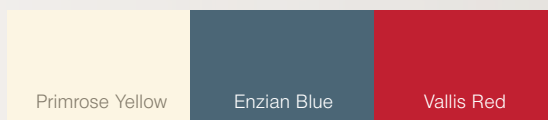

series hardware

# Emtek®

EMTEK's unique interconnected feature provides the security of deadbolt locking while providing panic-proof exiting utilizing simultaneous retraction of both latch and deadbolt from the inside, by operation of the knob/lever.



- **Heavy Duty Diecast Construction**  
For long lasting beauty
- **Durable Springs**  
To prevent lever sag
- **Threaded Brass Tubes**  
Solid brass nose bolts & sintered metal cams
- **Lifetime Mechanical Warranty**  
Our guarantee of value
- **Lifetime Anti-tarnish Finish Warranty**  
Beauty for life\*

All Emtek hardware is available in these finishes

Lifetime Bright Brass

Lifetime Satin Nickel

Oil Rubbed Bronze\*

\* Because of the nature of the finish, Oil Rubbed Bronze has no finish warranty.



Oil Rubbed Bronze Finish with use

Emtek's oil rubbed bronze finish is underlain with copper. Normal use will produce natural oxidation of the finish and reveal rich highlights on raised portions of the design.

## Exterior Styles



Melrose



Imperial



Ribbon & Reed



Orleans



Marietta

## Interior Styles



Egg  
Shown on  
Melrose



Egg  
Shown on  
Marietta



Cortina  
Shown on  
Orleans



Turino  
Shown on  
Imperial and  
Ribbon & Reed

series hardware

# Schlage® Vintage

Schlage Vintage series hardware offers you much more than just great looks. Look to Schlage for hardware that looks great and lasts.



- **Solid Cast Brass**  
For long lasting beauty
- **Maximum Security Deadbolt**  
For peace of mind
- **Nickel Silver Pins and Keys**  
For smooth, reliable operation
- **Heavy Duty Springs**  
For durable and "droop-free" levers
- **Superior Parts and Design**  
Tested for over 400,000 cycles of operation
- **Lifetime Mechanical Warranty**  
Our guarantee of value
- **Lifetime Anti-tarnish Finish Warranty Available**  
Beauty for life

All Schlage hardware is available in these finishes

Lifetime & 10-Year Bright Brass

Lifetime Satin Nickel

10-Year Antique Brass

Lifetime Aged Bronze

### Exterior Styles



Addison

Camelot

Plymouth

### Interior Styles



Georgian

Accent

Flair

Accent/Addison

lockset & deadbolt

# Schlage® Touchpad Electronic

Electronic locksets and deadbolts utilize Schlage's Innovative keyless access. It's convenient and is customizable to fit your security needs.



- Deadbolt is available with any Schlage entry hardware
- 9-volt battery included
- Lighted keypad
- Up to 19 user codes
- Easy to add or delete codes
- Lifetime mechanical and 1-year electronics warranty

## Electronic Deadbolt



## Accent Lever Electronic Lockset



Exterior  
Bright Brass



Interior



Satin Nickel



Antique Brass



Aged Bronze

All Schlage Touchpad Electronic hardware is available in these finishes

Lifetime & 10-Year Bright Brass

Lifetime Satin Nickel

10-Year Antique Brass

Lifetime Aged Bronze

# Schlage® LiNK.

Access to a whole new level of freedom.

Introducing Schlage LiNK. Now, no matter where you go, the front door is within reach. That's because Schlage LiNK is more than a lockset. It's a brilliant new way to enhance your home's security, and your family's peace of mind.

On the surface, Schlage LiNK looks like a keypad lock — and it is. But it also features technology

that allows you to use your smart phone or computer to remotely unlock your doors, monitor entry, and change pass codes. You can even pair Schlage LiNK with other household items like lights and appliances for additional security and convenience.

That's freedom. That's intelligence.  
That's Schlage LiNK.



Hardware

Schlage LiNK Dead Bolt



Schlage LiNK Lockset



All Schlage LiNK Touchpad Electronic hardware is available in these finishes

Lifetime & 10-Year Bright Brass

Lifetime Satin Nickel

Lifetime Aged Bronze

Schlage LiNK requires a monthly subscription fee to enable remote access from your computer or smart phone over the internet. For more information on Schlage LiNK, please go to [www.link.schlage.com](http://www.link.schlage.com)

multipoint hardware

# Trilennium™

The Trilennium multipoint hardware system provides more than just security. It offers homeowners better door closure and sealing than a single point lock.



- All three points latch with a 1" deadbolt throw.
- Top and bottom latch design allows for door misalignment and  $\frac{3}{16}$ " pull-in when deadbolted.
- Release of the latch and deadbolt is a single downward movement.
- Deadbolts include anti-saw hardened steel pin.
- Lifetime finish warranty and 10-year warranty on materials and workmanship.
- Hardware available in your choice of Bright Brass or Satin Nickel.

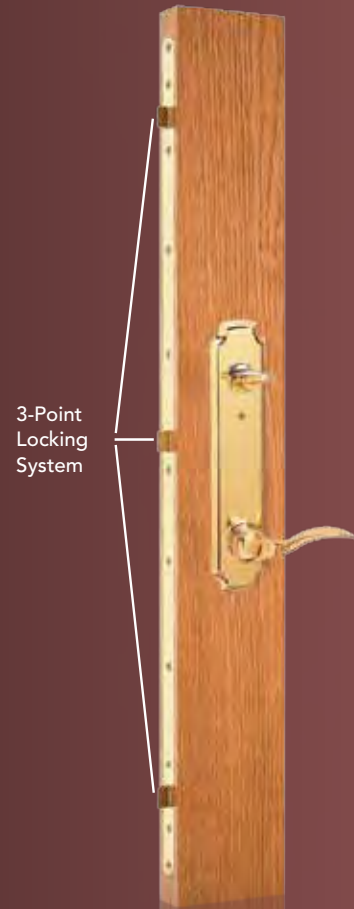

All Emtex hardware is available in these finishes

Lifetime Bright Brass

Lifetime Satin Nickel

Lifetime Flat Bronze\*

\* Flat Bronze coordinates (but is not an exact match) with Aged Bronze accessories.



Eclipse Entrance Grip †



Pinnacle

Eclipse

† All Eclipse Entrance Grip Handlesets come with this interior hardware (above)

Trilennium hardware is required on all 8' Signet and Heritage fiberglass doors. Optional on all other fiberglass doors.

Also available on all 20-gauge Legacy steel doors.

# Schlage® Classic

series hardware

Schlage Classic hardware can fill your needs when you desire something understated, yet beautiful and lasting. Choose from an assortment of finishes.



## Schlage Classic Door Locksets & Deadbolts



Accent/Addison Keyed Lockset



Accent Keyed Lockset



Georgian Key in Knob Lockset



Flair Keyed Lockset



Georgian Key in Knob Lockset (interior view showing turn lock)



Maximum Security Thumbturn 1" Deadbolt



Maximum Security Double Key 1" Deadbolt

Also available as Interior Only 1-Sided Thumbturn 1" Deadbolt (Only available in 20-Gauge Steel or Signet Fiberglass)

## Schlage Passage Latch



Accent Passage Latch



Accent/Addison Passage Latch



Flair Passage Latch



Georgian Passage Latch

All Schlage Classic Series hardware is available in these finishes

Lifetime & 10-Year Bright Brass

Lifetime Satin Nickel

10-Year Antique Brass

Lifetime Aged Bronze

## Solid Brass Accessories

Sometimes the smallest things make the biggest difference. Our solid brass accessories add a lot to the look of your entry system.



## Optional Decorative Hinges

Also available in Satin Nickel & Oil Rubbed Bronze (Inswing only)

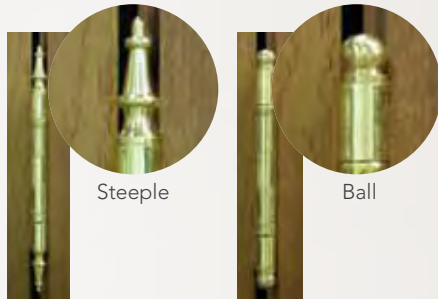

## Accessories Finish Availability 5-Year Mechanical Warranty

Accessories	Lifetime Finish			5-Year Finish		No Finish Warranty
	Bright Brass	Satin Nickel	Aged Bronze	Bright Brass	Antique Brass	Oil Rubbed Bronze
Colonial Door Knocker	•	•				•
Classic Door Knocker/Viewer	•	•	•	•	•	
Classic Door Knocker	•	•	•	•	•	
Magazine Slot*	•	•	•	•	•	
Mail Slot*	•	•	•	•	•	
Kick Plate	•	•	•	•	•	
Peek-O				•	•	
Long Trim Handle				•	•	

\* Mail slot and magazine slot are not available on 009, 008P, 110, 240, 243 and 440 door styles.

\*\* Peepsite available in Bright Brass, Chrome (recommended for use with Satin Nickel hardware finish) and Aged/Antique (recommended for use with Aged Bronze or Antique Brass hardware finish) with 5-year finish warranty.

❖ Double key deadbolts on residences and any door in any structure which is used for egress are a safety hazard in times of emergency.

# Options



## InVent™ Retractable Screens

Upgrade your door with our InVent Retractable Screens. Now our color matched retractable screen is factory installed and available in custom sizes.

- Disappears into the natural recesses of the frame making them virtually invisible.
- Glides within the rails – no wheels or rollers to replace or lubricate.
- Screen expands upon impact – prevents damage or injury.
- Full length magnetic seal and a thick insect pile.
- A patent pending quiet, smooth brake system.
- Factory installed to ensure the most precise fit.
- Housing is color matched to all of our paint colors.
- Easy access to the screen cartridge makes screen replacement simple.
- Available for single, french or patio doors.
- Available in 8' doors.

Pg 92 ProVia Door Price List



## Freedom Pet Door

Factory Installed - Available on Flush Doors Only.

- Solid aluminum construction with locking panel
- Soft single flap for tight weather seal
- Available on the following styles: 001, 430DC-F, 430VNT-F, 430DC-EG-F, 430DC-IGT-F, 100DC, 101DC, 131DC & 306DC
- Also available on storm doors. See page 105.

### Medium

8 $\frac{1}{8}$ " x 11 $\frac{3}{4}$ " opening for pets up to 40 lbs.

### Large

10 $\frac{1}{8}$ " x 15 $\frac{3}{4}$ " opening for pets up to 100 lbs.

Pg 92 ProVia Door Price List



### Casing

Put the finishing touch on the inside of your entryway with our beautiful interior casing. Available in Cherry, Mahogany, Oak or Poplar wood.

- 2½" Modern
- 2½" Colonial
- 3½" Colonial



Available for any door configuration including transoms.

Signet stains are available on Cherry, Mahogany or Oak casing and Heritage stains are available on Oak or Poplar casing.

Paint finishes are available on Oak or Poplar casing.

Pg 97 ProVia Door Price List

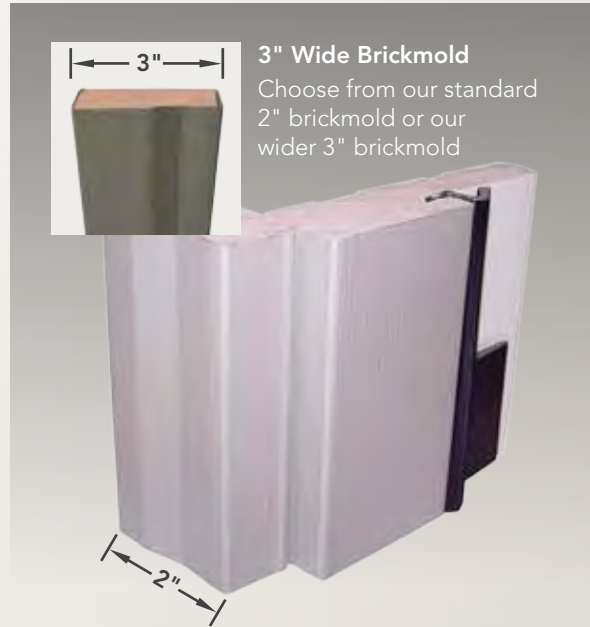

### Aluminum Pre-fit Cladding

is worth the small investment. You can add pre-fit cladding to any Full Wood Frame entry system.

- Protective
- Maintenance-free
- Stays beautiful
- Factory applied
- Available in all our featured paint colors and two coordinating stain colors.

### Cladding Colors

Snow Mist	Café Cream
Chateau	Sandpiper Beige
Sandstone	Sterling Gray
Clay	Geneva Blue
Forest Green	Mountain Berry
Rustic Bronze	Tudor Brown
Coal Black	Oak
Cherry	

Pg 99 ProVia Door Price List

# 8' Doors



All 8' Decorative Glass doors (excluding Tuscany) can be ENERGY STAR qualified depending on the glazing system you choose. This chart indicates which glazing system is required for ENERGY STAR qualification, as well as availability.

8' Doors	Glazing Systems			
Privacy Clear Glass	TLK	TLA	DLA	DC
Internal Blinds Internal Grids	DLA	DC		

**ENERGY STAR Qualified**  
Refer to pg. 13 for Glazing Systems information

Since Low-E glass has a slight color tint, it is recommended that sidelites be ordered with the same glazing system as the door.

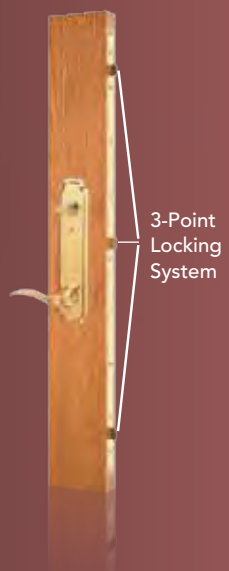

3-Point Locking System

Trilennium hardware is required on all 8' fiberglass doors.

See page 72 for more information on Trilennium hardware.

## 8' Glass Options



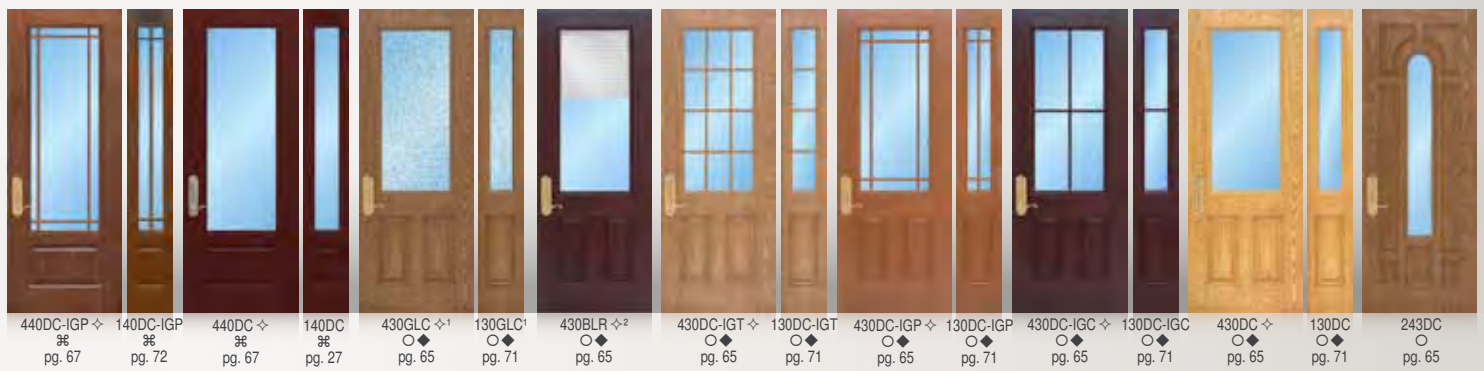

## 8' Doors Without Glass



All 8' doors without glass are ENERGY STAR qualified.

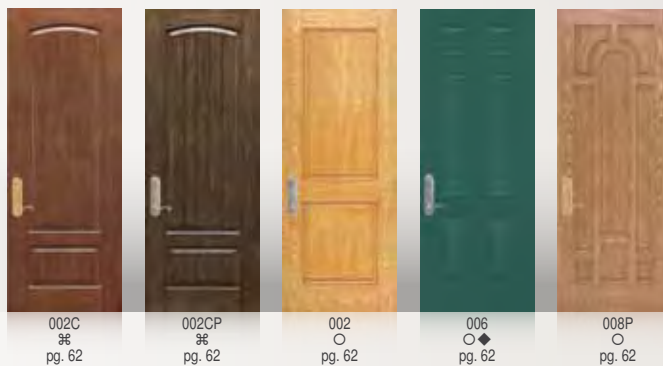

- ⚡ Signet Cherry Series Fiberglass
- Heritage Fiberglass
- ◆ Smooth Steel
- ⚡ Also available in 1 panel (002)
- <sup>1</sup> Also available in TAF, CHI, WAT & OBS
- <sup>2</sup> Also available in BLR-IGT, BLR-IGP & BLR-IGC
- <sup>3</sup> Available in Brass, Zinc and Patina caming.
- <sup>4</sup> Available in Zinc and Patina caming.
- <sup>5</sup> Available in Brass and Zinc caming.

doors

# French

French doors make an elegant statement like nothing else. Express your personality by creating a simple yet striking entry. Make it as ornate and beautiful as you like.



006, Custom sized 512DC-IGS

- All door styles are available as a French Door
- Available with Full Wood Frame or Steel L-Frame
- Hinged on each end with door knobs in the center
- Available with either Left or Right door Active (main entryway)
- Center astragal is attached to the Inactive door and includes top and bottom slide bolts (used to open Inactive door)
- Available as Inswing or Outswing
- Header security plate standard on Full Wood Frame
- Hardware Installation: locksets, deadbolts and kickplates will be installed on active and inactive door, all other hardware on active door only
- Optional InVent™ Retractable Screens

### Unequal French Doors



You now have the ability to utilize a larger entrance door day-to-day, yet have the option to open the smaller, inactive door to gain full access.

Available in smooth steel only. Internal blind sizes are limited. See Price List for details.



460LEH  
● ■ ◆  
pg. 39

460LEH  
● ■ ◆  
pg. 39

Custom size clear glass transom pg. 84



460DC-IGT  
● ■ ◆  
pg. 41

460DC-IGT  
● ■ ◆  
pg. 41



160STJ  
● ■ ◆  
pg. 53

460STJ  
● ■ ◆  
pg. 38

460STJ  
● ■ ◆  
pg. 38

160STJ  
● ■ ◆  
pg. 53

- Signet and Heritage Fiberglass
- 20-gauge Woodgrain Textured Steel
- ◆ Smooth Steel

# Designer Patio Door

Designer Patio doors are swinging patio door systems available in 2 or 3-lite units and constructed of the same solid quality Signet™ and Heritage™ Fiberglass, and Legacy™ Woodgrain Textured or Smooth Steel doors as our entry door units.



## Patio Door Standard Features



A **keyed Schlage® flair handleset with a Maximum Security thumbturn deadbolt** is included. Choose from bright brass, antique brass, satin nickel or aged bronze finish. Optional Lifetime finish available.



The lock area is reinforced with a **20-gauge steel security plate** for added strength.



**Spring-loaded latch system** automatically engages upon closing. Latch also includes interior locking feature. **NEW BetterVue™ fiberglass screen** is standard. Heavy-duty fiberglass, aluminum, or SeeVue™ stainless steel screen is optional.



Suspended by ball bearing rollers this **top-hung heavy duty aluminum screen frame** reduces binding, creating effortless operation. Screen frames are available in all 16 colors.



Our **Sahara™ heavy-duty extruded sill** has a 1½" wide thermal barrier oak-like riser that will not rot or warp and is non-conductive. Also available with an anodized brass or bronze finish.

Bronze threshold comes with a color coordinated riser.

## Door Swing

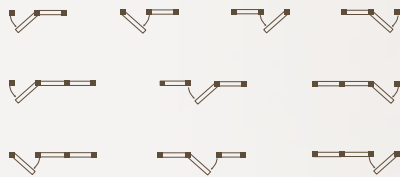

### Options:

**Finishes** - Patio doors are available in all finishes shown on pages 64-65.

**Optional InVent Retractable Screen** - See page 76.

◀ **Door Swing** - (Doors viewed from above. Inswing only.)

## Custom Widths & Heights.

Need a little more height or a little less width? We are pleased to offer customized patio door widths and heights in 1/8" increments.

## Standard Sizing Information

Patio Unit Sizing	Downsized (Standard) Patio Doors					Full Size Patio Doors				
	Patio Width	Unit Size	Rough Opening	Brickmold to Brickmold*	Patio Height	Patio Width	Unit Size	Rough Opening	Brickmold to Brickmold*	Patio Height
	60"	59¼"	60"	61½"	Rough Opening Height 79¾"	60"	61⅞"	62⅞"	64⅞"	Rough Opening Height 82"
	64"	63¼"	64"	65½"		64"	65⅞"	66⅞"	68⅞"	
	68"	67¼"	68"	69½"		68"	69⅞"	70⅞"	72⅞"	
	72"	71¼"	72"	73½"	Unit Height Not Including Brickmold 79¼"	72"	73⅞"	74⅞"	76⅞"	Unit Height Not Including Brickmold 81½"
	90"	88⅞"	89⅞"	91⅞"	Unit Height Including Brickmold* 80⅝"	90"	91⅞"	92⅞"	94¼"	Unit Height Including Brickmold* 82⅞"
	96"	94⅞"	95⅞"	97⅞"		96"	97⅞"	98⅞"	100¼"	
	102"	100⅞"	101⅞"	103⅞"		102"	103⅞"	104⅞"	106¼"	
	108"	106⅞"	107⅞"	109⅞"		108"	109⅞"	110⅞"	112¼"	

\* Optional Aluminum Frame Cladding will increase brickmold to brickmold width by ¼" and height by ⅛". Not all sizes available in all door types.

# Prestige™ Vinyl Patio Doors



All Prestige Patio Doors includes our **ComforTech Glazing System**.



Prestige Vinyl Patio Doors are tested against the most stringent industry standards for air and water infiltration, wind-load resistance, ease of operation, forced entry and much more. This means you'll have lower heating and air-conditioning costs, easier cleaning, low maintenance and increased comfort.



## Standard Features



**Strong, multi-chamber profiles** and 5½" frame depth offer greater thermal efficiency and increased sound abatement.



**Galvanized steel reinforced panels** ensure rigidity and stable operation.



The **vent lock** adds peace of mind when you want to leave the door open for ventilation yet keep would-be intruders out.



Fixed and mobile **panel rails meet and interlock perfectly**, making removal from the outside virtually impossible. **Lower sill design** provides safer entry and exit.

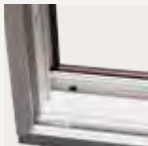

**Sill is reinforced with galvanized steel.** Pair that with our **patented water draining system**, and it results in an efficient and durable base for our patio door.



**Patented sliding system** features four adjustable 1" wheels per operating panel to ensure smooth, easy and quiet operation.



Suspended by ball bearing rollers this **top-hung heavy duty aluminum screen frame** reduces binding, creating effortless operation.



**Spring-loaded latch system** automatically engages upon closing. Latch also includes interior locking feature. **NEW BetterVue™ fiberglass screen** is standard. Heavy-duty fiberglass, aluminum, or SeeVue™ stainless steel screen is optional.

**NEW!**  
for 2012



### 8000 Series Features

- ComforTech™ TLK triple glazed warm edge glazing system with high performance Low-E Krypton glass
- Woodgrain interior
- Secondary ventilation lock
- Multi-point locking Bright Brass or Satin Nickel handleset with keylock.

### 7000 Series Features

- ComforTech™ DLA warm edge glazing system with high performance Low-E Argon glass
- Secondary ventilation lock
- Multi-point locking color matched handleset on white or beige patio doors.



All 8000 and 7000 Series Prestige Patio Doors with options as shown are ENERGY STAR Qualified.

# Prestige™ Options

Customizing  
your patio door  
is easy.



**INSPIRATIONS™**  
art glass ■■■

Inspirations Art Glass is available in entry doors, storm doors, patio doors, and vinyl windows. Ask for our Inspirations Art Glass brochure to see all our designs, color palettes and style availability or customize your design with our interactive visualization program ProVia Studio™.

## Available Options:

*See Price List for option availability.*

- ComforTech™ TLA and TLK triple-glazed glass
- Tinted glass in bronze, gray or green
- Azurlite® glass
- Painted aluminum internal grid in flat or contoured
- Woodgrain contoured internal grid
- Traditional beveled glass
- Single Prairie beveled glass
- Single and Double Prairie internal grids
- Keylock available for all hardware
- 8' wide units can be ordered assembled or knock-down

**Internal Blinds** Internal Blinds provide exceptional privacy and light control, however, Prestige Patio Doors with Internal Blinds are not ENERGY STAR qualified.



- Ultra-Privacy edge channel design keeps out light and prying eyes
- Blinds tilt, raise and lower using the convenient fingertip adjustment slides
- Easy to clean; no more dusting of blinds
- 10-Year Warranty
- Available as upgrade to 7000 series
- Available in standard sizes only
- Available in white blinds only
- Available in 1, 2, 3, and 4 lite models (n/a in 50" x 80" or 96" x 80" sizes)

### Hardware Options

Our Prestige Patio Door comes with multipoint mortise hardware available in White or Beige. Optional keylock available. Optional solid brass hardware with keylock available in Bright Brass or Satin Nickel finish.

#### Standard Hardware



White Interior

Beige Interior

#### Optional Hardware with keylock



Bright Brass Interior

Satin Nickel Interior

**Configuration** Available in 2, 3 or 4-panel configurations and standard and custom sizes

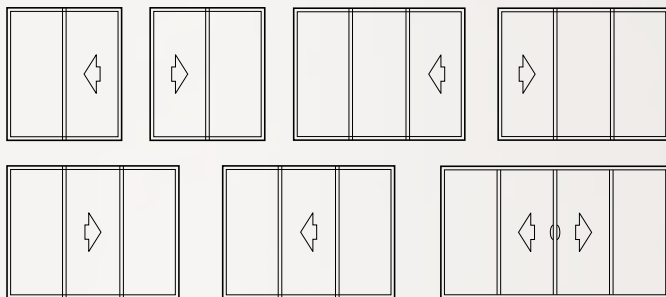

**Colors** (Woodgrain doors come with White or Beige exterior)

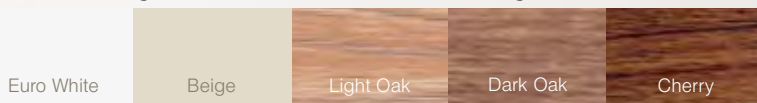

Euro White

Beige

Light Oak

Dark Oak

Cherry

# Storm Doors

Every storm door is individually customized to the highest standards in the residential market for homeowners who appreciate impeccable, uncompromising quality.



291 Full View



## Storm Door Paint Finishing System

Paint is electrostatically applied with a vertical hydraulic reciprocator using a turbo disc that atomizes the paint particles for better coverage of contoured extrusions.



## Storm Door Paint Colors

To select stain color, refer to our color selector for accurate color representation.

Snow Mist	Cafe Cream	Chateau	Sandpiper Beige	Sandstone
Sterling Gray	Clay	Geneva Blue	Forest Green	Mountain Berry
Rustic Bronze	Tudor Brown	Coal Black		

## Limited Colors

Available on entry doors and storm doors.

Matching cladding and caulking not available.

Primrose Yellow
Enzian Blue
Vallis Red

# Storm Door Construction

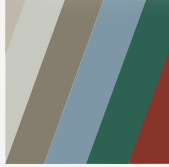

**Durable, oven-baked polyester finishes** are backed by a Lifetime Warranty for lasting beauty and low maintenance.



**Extruded aluminum frame** adds beauty to your door by virtue of the rounded **cove molding along the glass edge** of the extrusion.

All our storm doors are constructed with **tempered safety glass**.



You'll appreciate the finished look of our **color matched aluminum installation screw covers**.

Each door features **quality hardware** that adds beauty and functionality to your new storm door. Varies by model.



Sashes are secured by our **color matched polycarbonate clips or an internal sash lock system**. Varies by model.



Smooth function is essential. That's why we include a **quality door closer** in every storm door package. Varies by model.

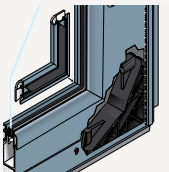

**Corrosion proof corner gussets** enhance the structural integrity of the door.

**Color matched bottom expanders** allow for a beautiful custom fit to any entry.



**Our bottom expander with sweep** allows for adjustment to ensure a snug fit as needed. Varies by model.



# Storm Door Details

The details are the small things that set our storm doors apart from the competition. A lot of small things add up to a big difference.

Our storm doors excel in Beauty, Durability, Security and Energy Efficiency. And we offer a Lifetime Limited Transferable Warranty on all our storm doors.



595 Full View Double Prairie with Beveled Glass

# Storm Door Construction

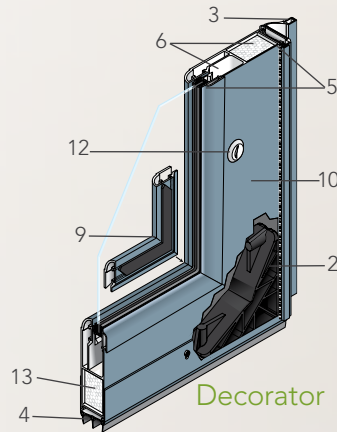
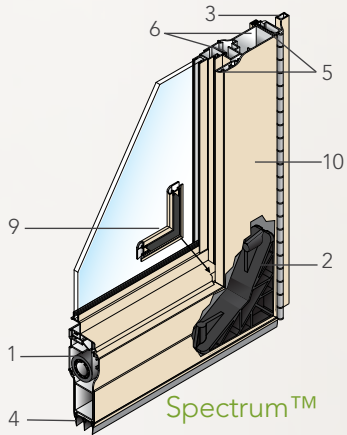

**Internal Sash Lock System**

This spring-loaded, flush mounted lock secures the glass virtually eliminating rattles and air leaks.

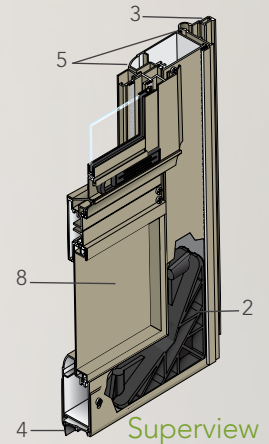
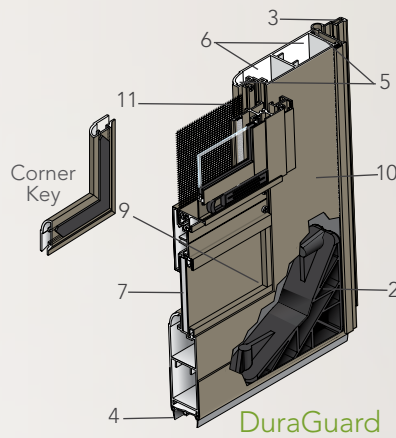
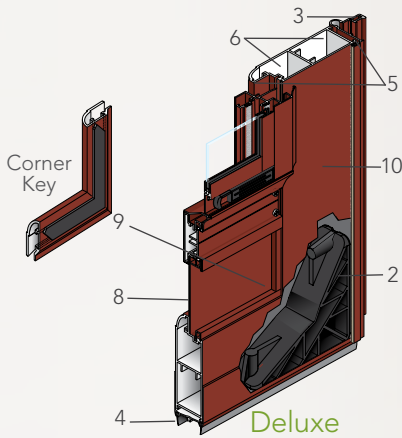

## Construction

	Spectrum™	Decorator	Deluxe	DuraGuard	Superview
1 InVent™ Retractable Screen System	●				
2 Outside corners are secured to corrosion proof gussets, for structural integrity	●	●	●	●	●
3 Color matched aluminum installation screw covers enhance the appearance of your door	●	●	●	●	●
4 The bottom sweep eliminates drafts	Triple	Triple	Double	Double	Single
5 The sculptured frame adds durability	1¼" x 4⅞"	1¼" x 4"	1¼" x 3⅞"	1¼" x 3⅞"	1¼" x 2⅞"
6 Multi-hollow construction provides greater strength and security than standard storm doors	●	●	●	●	
7 The reinforced aluminum kick panel adds durability	●			●	
8 The aluminum kick panel resists rust and adds strength			●		●
9 Corner keys provide added support to the inside of the door frame	●	●	●	●	
10 Aluminum wall thickness up to 20% thicker than industry standard	●	●	●	●	
11 The .023 gauge stainless steel screen offers extra security and protection (12 x 12 mesh)				●	
12 Sash/Screen secured by internal lock system or color matched polycarbonate clips		Internal Lock	Clips	Clips	Clips
13 Standard insulated frame core offers increased energy efficiency		●			
14 Screen included	●	Optional	●	●	●

storm doors

# Spectrum™

Spectrum Series brings you smooth functionality, beauty and durability. Our exclusive top & bottom InVent™ retractable screen system allows you more venting options than ever.



291 Full View

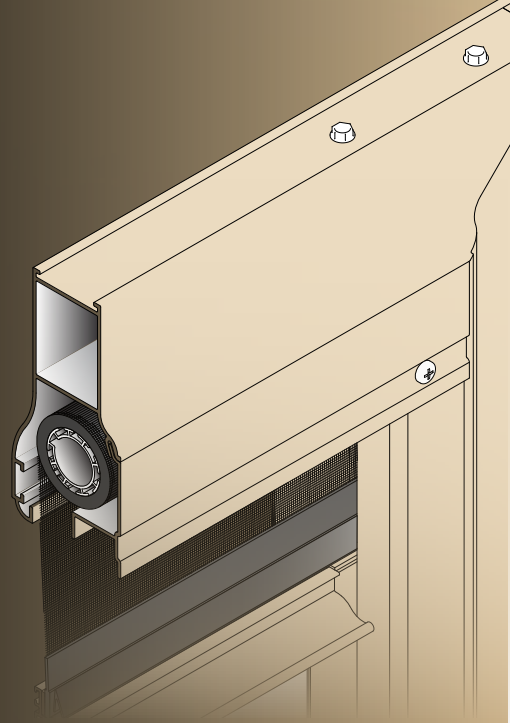

Featuring top and bottom InVent™ Retractable Screens

### Spectrum Storm Doors Include:

- Two InVent™ retractable screens with Compound Tension sashes
- Triple seal bottom sweep
- 1¼" x 4¾" wide sculptured frame

## Standard Hardware & Accessories

Bright Brass Sierra solid brass mortise hardware ♦

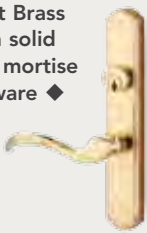

Bright Brass piano hinge ♦

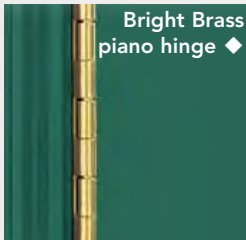

1½" brass-look bottom expander

Color matched dual closers



♦ Satin nickel hardware, piano hinge and bottom expander are standard on Spectrum storm doors with zinc caming and Inspirations Art Glass.

# Spectrum Styles



#296-B Full View Double Prairie with Beveled Glass and Brass Inlay



#296-Z Full View Double Prairie with Beveled Glass and Zinc Inlay\*



#295 Full View Double Prairie with Beveled Glass



#291 Full View\*  
\* Inspirations Glass available in #291 Full View



#298-B Three-quarter View with Beveled Glass and Brass Inlay



#298-Z Three-quarter View with Beveled Glass and Zinc Inlay\*



#298-VG Three-quarter View with Beveled Glass



#298 Three-quarter View



#292 Provincial Half-Lite



#293 Crossback Half-Lite

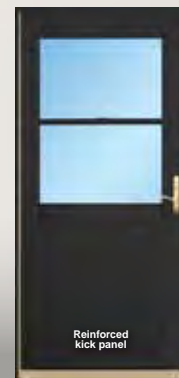

#279 Flush Half-Lite



#291SH Full View



#298SH Three-Quarter View



#274SH Half-Lite



#298-COS Cosmopolitan (Sedona)\*



#298-AZT Aztec (Coral Reef)\*



#298-TUL Tulips (Vineyard)\*

Ask to see our Inspirations Art Glass brochure for our complete selection of designs, color palettes, and style availability.

Spectrum Storm Doors

# Decorator series

Decorator Series provides a stylish, fresh look to accent your entry. Select one of the distinct styles from our Decorator Series storm doors.



593-B Full View Archway with Beveled Glass & Brass Inlay

## Decorator Series Storm Doors Include:

- Triple seal bottom sweep
- 1¼" x 4" wide sculptured frame

## Standard Hardware & Accessories

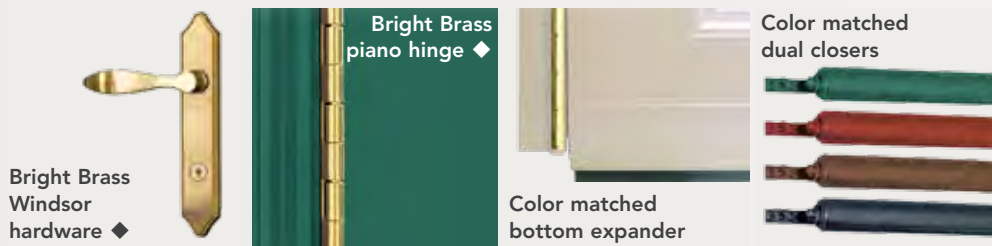

♦ Satin Nickel hardware and piano hinge are standard on Decorator storm doors with zinc coming and Inspirations Art Glass.

# Decorator Styles



#591 Full View Archway with Beveled Glass



#593-B Full View Archway with Beveled Glass & Brass Inlay



#593-Z Full View Archway with Beveled Glass & Zinc Inlay\*



#595 Full View Double Prairie with Beveled Glass



#596-B Full View Double Prairie with Beveled Glass & Brass Inlay



#596-Z Full View Double Prairie with Beveled Glass & Zinc Inlay\*



#590 Full View



INSPIRATIONS<sup>®</sup>  
art of glass

Ask to see our Inspirations Art Glass brochure for our complete selection of designs, color palettes, and style availability.



590-SYN Synergy (Vineyard)\*



590-VIN Vintage (Timberland)\*

Optional full screen with horizontal stabilizer bar available for all Decorator doors.

# series Deluxe

Deluxe Series is the answer whether you're looking for additional light, ventilation or protection from the elements. You'll find the exact style you're looking for in our Deluxe Series of storm doors.



382 Full View with Beveled Glass

## Deluxe Series Storm Doors Include:

- Double seal bottom sweep
- 1¼" x 3⅝" wide sculptured frame
- BetterVue™ Fiberglass Screen



## Standard Hardware & Accessories



Black Contemporary Curve lever with deadbolt

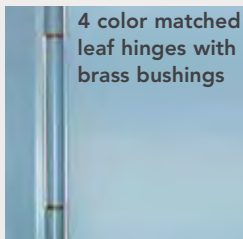

4 color matched leaf hinges with brass bushings

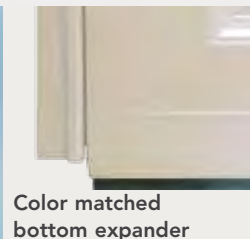

Color matched bottom expander

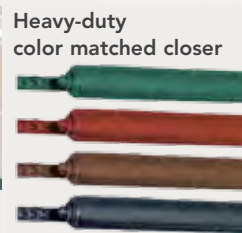

Heavy-duty color matched closer

# Deluxe Styles



#385 Full View Double Prairie with Beveled Glass  
Includes screen\*



#382 Full View with Beveled Glass  
Includes screen\*



#397 Full View  
Includes screen\*



#391 Full View Divided Lite  
Includes top screen



#396-V One-Lite with fixed .023 gauge stainless steel screen ventilated bottom & removable sash  
Includes top screen\*



#396 One-Lite  
Includes screen\*



#399 Self-Storing  
Includes full screen\*



#398 Hi-Lite  
Includes top screen



#389 Self-Storing  
Includes full screen\*



#392 Provincial Self-Storing  
Includes full screen\*



#394 Provincial  
Includes screen



#393 Crossback Self-Storing  
Includes full screen\*



#395 Crossback  
Includes screen



#379 Self-Storing  
Includes full screen\*



#374 Flush Half-Lite  
Includes screen



#397-VIN  
Vintage (Timberland)



INSPIRATIONS<sup>®</sup>  
art glass

Ask to see our Inspirations Art Glass brochure for our complete selection of designs, color palettes, and style availability.

Deluxe Storm Doors

\* Full and One-Lite screens have horizontal stabilizer bar.

# series DuraGuard

DuraGuard is exactly what you need if you're concerned about keeping your small children and pets safely inside, select one of our doors with heavy-duty non-removable stainless steel screening.



097 Screen Door

## DuraGuard Series Storm Doors Include:

- Double seal bottom sweep
- Fixed .023 stainless steel screen
- 1¼" x 3⅝" wide sculptured frame



.023 stainless steel black screen is standard

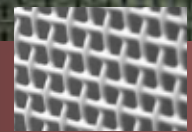

Also available in white

## Standard Hardware & Accessories



Black Contemporary Curve lever with deadbolt

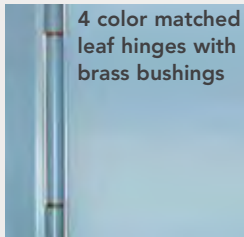

4 color matched leaf hinges with brass bushings

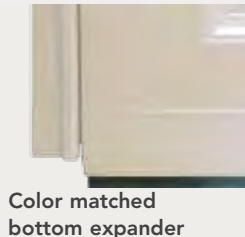

Color matched bottom expander



Heavy-duty color matched closer

## DuraGuard Styles



#097 Screen Door  
#097-G With glass insert



#096 Screen Door  
#096-G With glass insert  
Reinforced kick panel



#096-GV With ventilated bottom and removable top and bottom sashes



#099 Self-Storing Sash & screen  
Reinforced kick panel



#074 Flush Half Lite (Removable sash)  
Reinforced kick panel



#094 Provincial Half Lite (Removable sash)  
Reinforced, Dent-resistant kick panel



#095 Crossbuck Half Lite (Removable sash)  
Reinforced, Dent-resistant kick panel



#092 Provincial Self-Storing Includes full screen  
Reinforced, Dent-resistant kick panel



#093 Crossbuck Self-Storing Includes full screen  
Reinforced, Dent-resistant kick panel



#079 Self-Storing Includes full screen  
Reinforced kick panel

# Superview

series

Superview offers a selection of storm doors constructed for style and value in one complete package.



896 One-Lite

## Superview Series Storm Doors Include:

- Single seal bottom sweep
- 1 1/4" x 2 5/8" sculptured frame
- BetterVue™ Fiberglass Screen



## Standard Hardware & Accessories



**Black Pull Handle**  
Also available in White

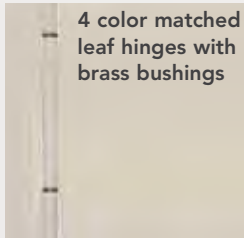

**4 color matched leaf hinges with brass bushings**



**Color matched bottom expander**

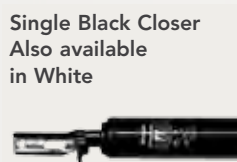

**Single Black Closer**  
Also available in White

## Superview Styles



#897 Full View  
Includes screen\*



#896 One-Lite  
Includes screen\*



#898 Hi-Lite  
Includes top screen



#899 Self-Storing  
Includes bottom  
screen



#895 Crossbuck  
Includes screen

Superview storm doors are available in the following colors only:

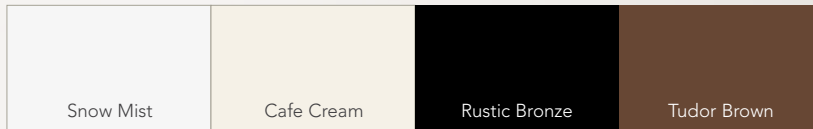

To select stain color, refer to our color selector for accurate color representation.

# Mortise Hardware

Mortise Hardware adds a special touch to your storm door with a solid brass handleset to suit your style. Our mortise hardware conveniently allows you to use the same key for your storm door and your ProVia entry door.



Our mortise hardware features a multi-point locking system for added strength and security not found on typical consumer-grade storm door hardware.



Satin Nickel Sierra Mortise Hardware

Sierra (Solid Brass Mortise)



DH 274



DH 273



DH 278



DH 266



Sierra Interior

Venice (Solid Brass Mortise)



DH 276



DH 275



DH 279



DH 267



Venice Interior

Hardware Finish Availability

Hardware Availability

Exterior Handle Styles	LIFETIME Bright Brass	LIFETIME Satin Nickel	LIFETIME Aged Bronze	10-Year Finish Antique Brass	Spectrum™	Decorator	Deluxe	DuraGuard	Superview
Sierra	●	●	●	●	Standard	■	■	■	
Venice	●	●	●	●	■	■	■	■	

● Interior handle finish matches exterior handle    ■ Available as an option

Mortise hardware requires a factory handleset prep and is not available on expander and double french doors.

# Hardware

With both elegance and durability, our hardware makes the right first impression. Choose from our wide selection of solid hardware to customize your storm door.

**NEW!**  
for 2012

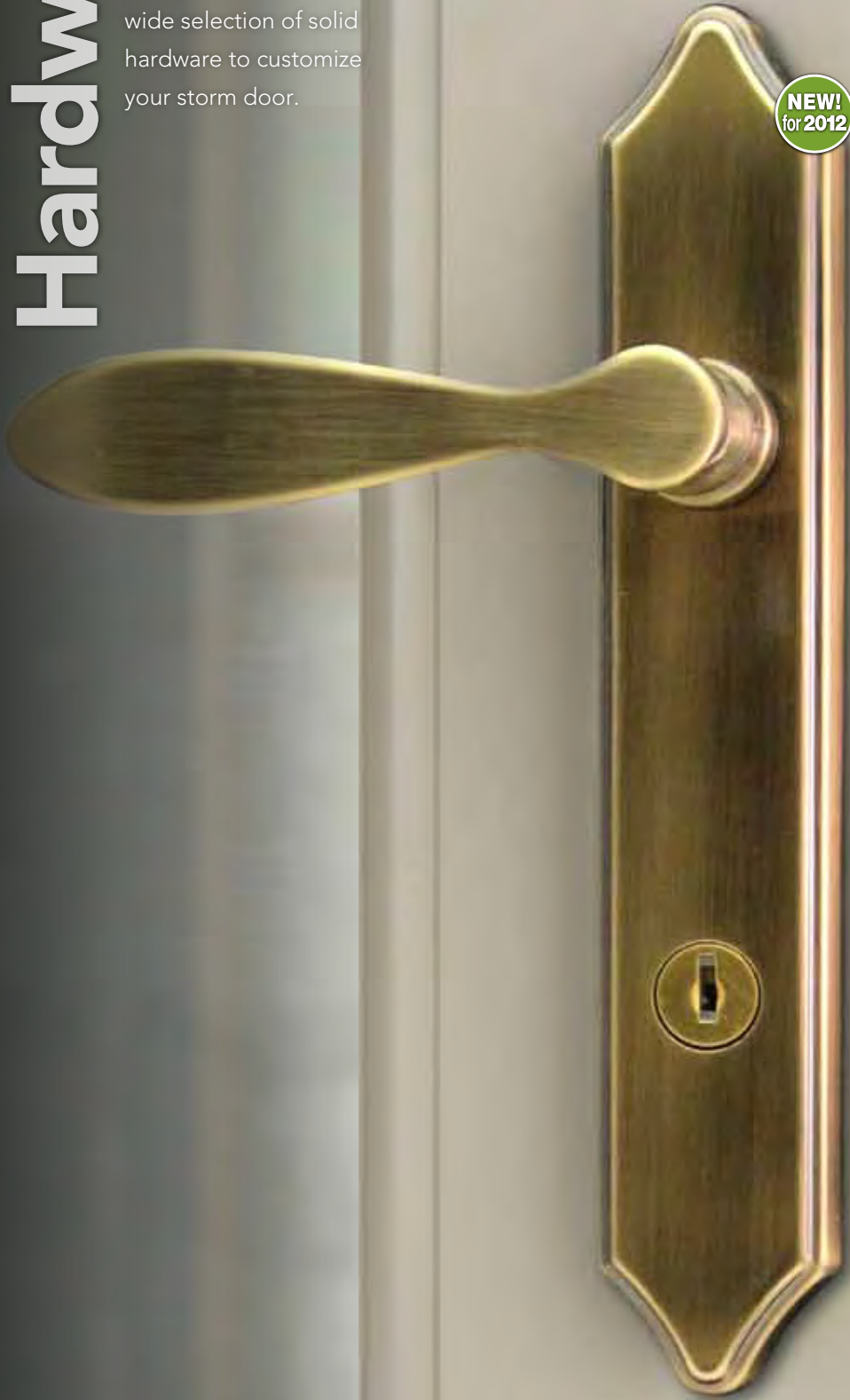

## Exterior Handles

### Windsor



DH 242



DH 241



DH 243



DH 244

### Townsend



DH 252



DH 251



DH 253



DH 254

### Contemporary Curve Lever



DH 232



DH 238



DH 230



DH 226



DH 228



DH 240

### Push Button



DH 201



DH 202/192



DH 181



DH 182

### Pull Handle

### Interior Handles



Windsor  
Townsend  
Contemporary Curve



Push Button  
(DH201 & DH202)



Push Button  
(DH192)  
Pull Handle

## Hardware Finish Availability

## Hardware Availability

Exterior Handle Styles	LIFETIME Bright Brass	LIFETIME Satin Nickel	LIFETIME Aged Bronze	1-Year Antique Brass	1-Year White	1-Year Black	Spectrum™	Decorator	Deluxe	DuraGuard	Superview
Windsor	●	●	●	● <small>NEW! for 2012</small>			■	Standard	■	■	■*
Townsend	●	●	●	● <small>NEW! for 2012</small>			■	■	■	■	■*
Contemporary Curve	●	●	●	●	●	●	■	■	Standard †	Standard †	■*
Push Button (DH201 & DH202)					●	●			■	■	■*
Push Button (DH192)						●					■
Pull Handle					●	●					Standard

● Interior handle finish matches exterior handle   ■ Available as an option   † Standard color is black or white   \* Not available on Superview Model #899

# Storm Door Accessories



## Freedom Pet Door

Factory Installed -  
Available on Flush Doors Only

- Solid aluminum construction with spring loaded interior cover
- Soft single flap for a tight weather seal
- White mitered aluminum frame with white aluminum cove
- Also available on entry doors  
See page 76
- Also available on additional storm door styles. See Price List pg. 130



#279 Flush Half-Lite  
with Pet Door Option



#379 Self-Storing  
with Pet Door Option  
Includes full screen



### Medium

8 $\frac{1}{8}$ " x 11 $\frac{3}{4}$ " opening for pets up to 40 lbs.

### Large

10 $\frac{1}{8}$ " x 15 $\frac{3}{4}$ " opening for pets up to 100 lbs.

## Piano Hinge and Bottom Expander

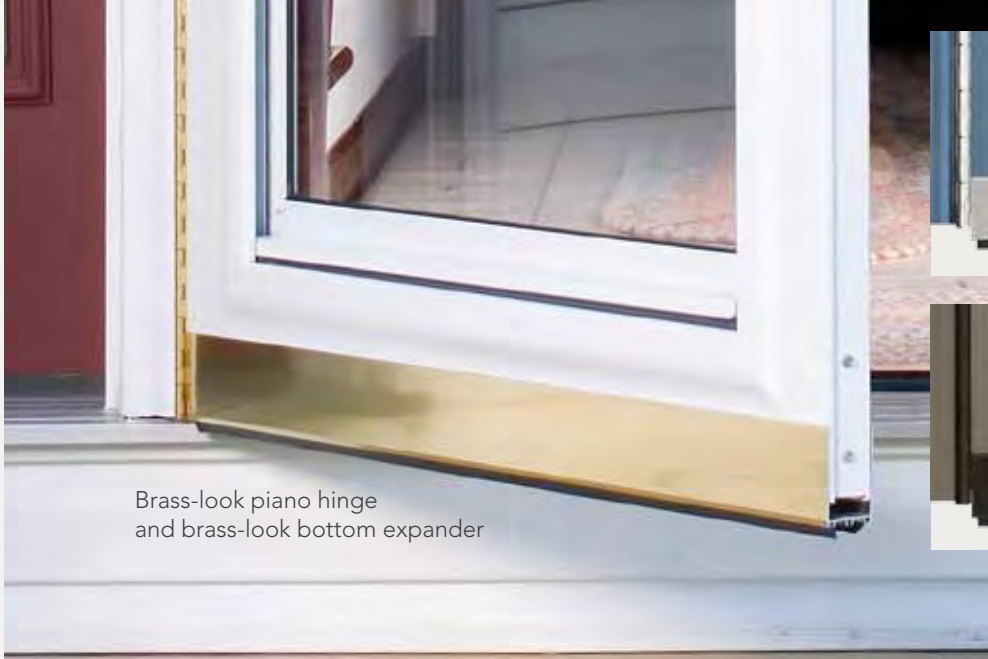

Brass-look piano hinge and brass-look bottom expander

Satin Nickel piano hinge and Satin Nickel bottom expander

Aged Bronze piano hinge and Aged Bronze bottom expander

## Easy-Set Closer



Just a slight push on the cap and it'll stay open. Push door open further and it releases. Color matched to door.

## Magazine & Mail Slot



Bright Brass, Satin Nickel and Aged Bronze magazine and mail slots. Available on #074, #079, #279, #374 and #379.

CARING FOR  
**DETAILS**  
IN WAYS OTHERS WON'T

Across ProVia's complete line of products, you can be confident we put the same care into every detail of windows, siding and stone you've come to value in our doors.

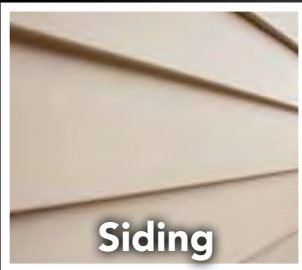
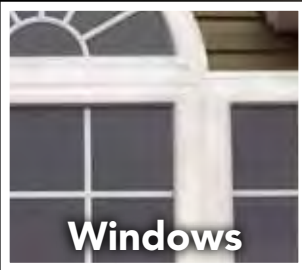
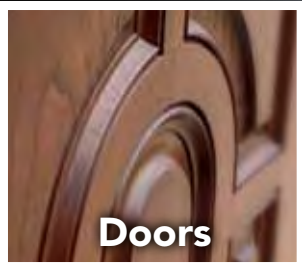

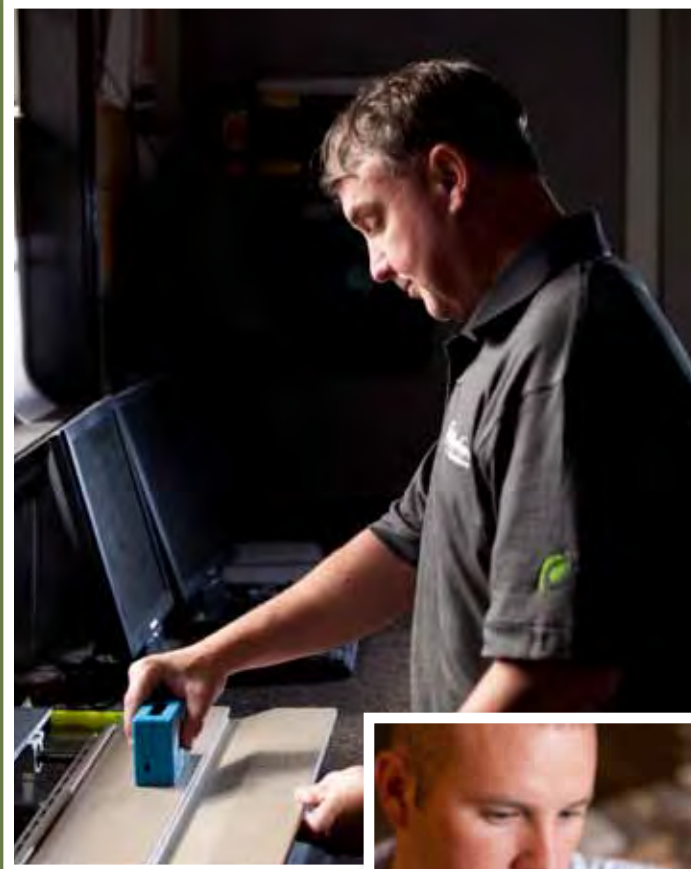

At ProVia, we care about our customers as much as we do the products and services we meticulously provide. We combine old-world craftsmanship with state-of-the-art technology to deliver personalized care with every order. We invite you to experience ProVia's full line of products crafted the Professional Way - which includes the industry's best in doors, windows, siding and stone.

Look at our full line of products at:

[www.proviaproducts.com](http://www.proviaproducts.com)





THE PROFESSIONAL WAY

Doors • Windows • Siding • Stone  
[www.proviaproducts.com](http://www.proviaproducts.com)

© 2012 ProVia  
P-MK-030005-12 11/11 75M - H

Distributed by: